

Glueability of resource proof-structures: inverting the Taylor expansion (long version)

Giulio Guerrieri 

University of Bath, Department of Computer Science, Bath, UK
g.guerrieri@bath.ac.uk

Luc Pellissier

Université de Paris, IRIF, CNRS, F-75013 Paris, France
pellissier@irif.fr

Lorenzo Tortora de Falco

Università Roma Tre, Dipartimento di Matematica e Fisica, Rome, Italy
tortora@uniroma3.it

Abstract

A Multiplicative-Exponential Linear Logic (MELL) proof-structure can be expanded into a set of resource proof-structures: its Taylor expansion. We introduce a new criterion characterizing those sets of resource proof-structures that are part of the Taylor expansion of some MELL proof-structure, through a rewriting system acting both on resource and MELL proof-structures.

2012 ACM Subject Classification Theory of computation → Linear logic

Keywords and phrases linear logic, Taylor expansion, proof-net, proof-structure

Digital Object Identifier 10.4230/LIPIcs.CVIT.2016.23

1 Introduction

Resource λ -calculus and the Taylor expansion Girard’s linear logic (LL, [15]) is a refinement of intuitionistic and classical logic that isolates the infinitary parts of reasoning in two (dual) modalities: the *exponentials* ! and ?. They give a logical status to the operations of memory management such as *copying* and *erasing*: a linear proof corresponds—via Curry–Howard isomorphism—to a program that uses its argument *linearly*, *i.e.* exactly once, while an exponential proof corresponds to a program that can use its argument at will.

The intuition that linear programs are analogous to linear functions (as studied in linear algebra) while exponential programs mirror a more general class of analytic functions got a technical incarnation in Ehrhard’s work [9, 10] on LL-based denotational semantics for the λ -calculus. This investigation has been then internalized in the syntax, yielding the *resource λ -calculus* [5, 11, 14]: there, copying and erasing are forbidden and replaced by the possibility to apply a function to a *bag* of resource λ -terms which specifies how many times an argument can be linearly passed to the function, so as to represent only bounded computations.

The *Taylor expansion* associates with an ordinary λ -term a (generally infinite) set of resource λ -terms, recursively approximating the usual application: the Taylor expansion of the λ -term MN is made of resource λ -terms of the form $t[u_1, \dots, u_n]$, where t is a resource λ -term in the Taylor expansions of M , and $[u_1, \dots, u_n]$ is a bag of arbitrarily finitely many (possibly 0) resource λ -terms in the Taylor expansion of N . Roughly, the idea is to decompose a program into a set of purely “resource-sensitive programs”, all of them containing only bounded (although possibly non-linear) calls to inputs. The notion of Taylor expansion has many applications in the theory of the λ -calculus, *e.g.* in the study of linear head reduction [12], normalization [23, 26], Böhm trees [4, 18], λ -theories [19], intersection types [21]. More generally, understanding the relation between a program and its Taylor expansion renews the logical approach to the quantitative analysis of computation started with the inception of LL.



© Giulio Guerrieri and Luc Pellissier and Lorenzo Tortora de Falco;
licensed under Creative Commons License CC-BY

42nd Conference on Very Important Topics (CVIT 2016).

Editors: John Q. Open and Joan R. Access; Article No. 23; pp. 23:1–23:21

Leibniz International Proceedings in Informatics



LIPICs Schloss Dagstuhl – Leibniz-Zentrum für Informatik, Dagstuhl Publishing, Germany

A natural question is the *inverse Taylor expansion problem*: how to characterize which sets of resource λ -terms are contained in the Taylor expansion of a same λ -term? Ehrhard and Regnier [14] defined a simple *coherence* relation such that a finite set of resource λ -terms is included in the Taylor expansion of a λ -term if and only if the elements of this set are pairwise coherent. Coherence is crucial in many structural properties of the resource λ -calculus, such as in the proof that in the λ -calculus normalization and Taylor expansion commute [12, 14].

We aim to solve the inverse Taylor expansion problem in the more general context of LL, more precisely in the *multiplicative-exponential fragment* MELL of LL, being aware that for MELL no coherence relation can solve the problem (see below).

Proof-nets, proof-structures and their Taylor expansion: seeing trees behind graphs In MELL, linearity and the sharp analysis of computations naturally lead to represent proofs in a more general *graph*-like syntax instead of a term-like or tree-like one.¹ Indeed, linear negation is involutive and classical duality can be interpreted as the possibility of juggling between different conclusions, without a distinguished output. Graphs representing proofs in MELL are called *proof-nets*: their syntax is richer and more expressive than the λ -calculus. Contrary to λ -terms, proof-nets are special inhabitants of the wider land of *proof-structures*: they can be characterized, among proof-structures, by abstract (geometric) conditions called correctness criteria [15]. The procedure of cut-elimination can be applied to proof-structures, and proof-nets can also be seen as the proof-structures with a good behavior with respect to cut-elimination [1]. Proof-structures can be interpreted in denotational models and proof-nets can be characterized among them by semantic means [24]. It is then natural to attack problems in the general framework of proof-structures. In this work, correctness plays no role at all, hence we will consider proof-structures and not only proof-nets. MELL proof-structures are a particular kind of graphs, whose edges are labeled by MELL formulæ and vertices by MELL connectives, and for which special subgraphs are highlighted, the *boxes*, representing the parts of the proof-structure that can be copied and discarded (*i.e.* called an unbounded number of times). A box is delimited from the rest of a proof-structure by exponential modalities: its border is made of one !-cell, its principal door, and arbitrarily many ?-cells, its auxiliary doors. Boxes are nested or disjoint (they cannot partially overlap), so as to add a tree-like structure to proof-structures *aside* from their graph-like nature.

As in λ -calculus, one can define [13] box-free *resource proof-structures*², where !-cells make resources available boundedly, and the *Taylor expansion* of MELL proof-structures into these resource proof-structures, that recursively copies the content of the boxes an arbitrary number of times. In fact, as somehow anticipated by Boudes [3], such a Taylor expansion operation can be carried on any tree-like structure. This primitive, abstract, notion of Taylor expansion can then be pulled back to the structure of interest, as shown in [17] and put forth again here.

The question of coherence for proof-structures The inverse Taylor expansion problem has a natural counterpart in the world of MELL proof-structures: given a set of resource proof-structures, is there a MELL proof-structure the expansion of which contains the set? Pagani and Tasson [22] give the following answer: it is possible to decide whether a finite set of resource proof-structures is a subset of the Taylor expansion of a same MELL proof-structure (and even possible to do it in non-deterministic polynomial time); but unlike the λ -calculus, the structure of the relation “being part of the Taylor expansion of a same proof-structure”

¹ A term-like object is essentially a tree, with one output (its root) and many inputs (its other leaves).

² Also known as differential proof-structures [6] or differential nets [13, 20, 7] or simple nets [22].

is *much more* complicated than a binary (or even n -ary) coherence. Indeed, for any $n > 1$, it is possible to find $n + 1$ resource proof-structures such that any n of them are in the Taylor expansion of some MELL proof-structure, but there is no MELL proof-structure whose Taylor expansion has all the $n + 1$ as elements (see our Example 21 and [25, pp. 244-246]).

In this work, we introduce a new combinatorial criterion, *glueability*, for deciding whether a set of resource proof-structures is a subset of the Taylor expansion of some MELL proof structure, based on a rewriting system on sequences of MELL formulæ. Our criterion is more general (and, we believe, simpler) than the one of [22], which is limited to the *cut-free* case with *atomic axioms* and characterizes only *finite* sets: we do not have these limitations. We believe that our criterion is a useful tool for studying proof-structures. We conjecture that it can be used to show that, for a suitable geometric restriction, a binary coherence relation does exist for resource proof-structures. It might also shed light on correctness and sequentialization.

As the proof-structures we consider are typed, an unrelated difficulty arises: a resource proof-structure might not be in the Taylor expansion of any MELL proof-structure, not because it does not respect the structure imposed by the Taylor expansion, but because its type is impossible.³ To solve this issue we enrich the MELL proof-structure syntax with a “universal” proof-structure: a special \boxtimes -cell (*daimon*) that can have any number of outputs of any types, and we allow it to appear inside a box, representing information plainly missing (see Section 8 for more details and the way this matter is handled by Pagani and Tasson [22]).

2 Outline and technical issues

The rewritings The essence of our rewriting system is not located on proof-structures but on lists of MELL formulæ (Definition 9). In a very down-to-earth way, this rewriting system is generated by elementary steps akin to rules of sequent calculus read from the *bottom up*: they act on a list of conclusions, analogous to a monolaterous right-handed sequent. These steps are actually more sequentialized than sequent calculus rules, as they do not allow for commutation. For instance, the rule corresponding to the introduction of a \otimes on the i -th formula, is defined as $\otimes_i : (\gamma_1, \dots, \gamma_{i-1}, A \otimes B, \gamma_{i+1}, \dots, \gamma_n) \rightarrow (\gamma_1, \dots, \gamma_{i-1}, A, B, \gamma_{i+1}, \dots, \gamma_n)$.

These rewrite steps then act on MELL proof-structures, coherently with their type, by modifying (most of the times, erasing) the cells directly connected to the conclusion of the proof-structure. Formally, this means that there is a functor $\mathbf{qMELL}^{\boxtimes}$ from the rewrite steps into the category \mathbf{Rel} of sets and relations, associating with a list of formulæ the set of MELL proof-structures with these conclusions, and with a rewrite step a relation implementing it (Definition 12). The rules *deconstruct* the proof-structure, starting from its conclusions. The rule \otimes_1 acts by removing a \otimes -cell on the first conclusion, replacing it by two conclusions.

These rules can only act on specific proof-structures, and indeed, capture a lot of their structure: \otimes_i can be applied to a MELL proof-structure R if and only if R has a \otimes -cell in the conclusion i (as opposed to, say, an axiom). So, in particular, every proof-structure is completely characterized by any sequence rewriting it to the empty proof-structure.

Naturality The same rules act also on sets of resource proof-structures, defining the functor $\mathfrak{PqDiLL}_0^{\boxtimes}$ from the rewrite steps into the category \mathbf{Rel} (Definition 17). When carefully defined, the Taylor expansion induces a *natural transformation* from $\mathfrak{PqDiLL}_0^{\boxtimes}$ to $\mathbf{qMELL}^{\boxtimes}$

³ Similarly, in the λ -calculus, there is no closed λ -term of type $X \rightarrow Y$ with $X \neq Y$ atomic, but the resource λ -term $(\lambda f.f)[\]$ can be given that type: the empty bag $[\]$ kills any information on the argument.

23:4 Glueability of resource proof-structures: inverting the Taylor expansion

(Theorem 18). By applying this naturality repeatedly, we get our characterization (Theorem 20): a set of resource proof-structures Π is a subset of the Taylor expansion of a MELL proof-structure iff there is a sequence rewriting Π to the singleton of the *empty* proof-structure.

The naturality property is not only a mean to get our characterization, but also an interesting result in itself: natural transformations can often be used to express fundamental properties in a mathematical context. In this case, the *Taylor expansion is natural* with respect to the possibility to build a proof-structure (both MELL or resource) by adding a cell to its conclusions or boxing it. Said differently, naturality of the Taylor expansion roughly means that the rewrite rules that deconstruct a MELL proof-structure R and a set of resource proof-structures in the Taylor expansion of R mimic each other.

Quasi-proof-structures and mix Our rewrite rules consume proof-structures from their conclusions. The rule corresponding to boxes in MELL opens a box by deleting its principal door (a $!$ -cell) and its border, while for a resource proof-structure it deletes a $!$ -cell and separates the different copies of the content of the box (possibly) represented by such a $!$ -cell. This operation is problematic in a twofold way. In a resource proof-structure, where the border of boxes is not marked, it is not clear how to identify such copies. On the other side, in a MELL proof-structure the content of a box is not to be treated as if it were at the same level as what is outside of the box: it can be copied many times or erased, while what is outside boxes cannot, and treating the content in the same way as the outside suppresses this distinction, which is crucial in LL. So, we need to remember that the content of a box, even if it is at depth 0 (*i.e.* not contained in any other box) after erasing the box wrapping it by means of our rewrite rules, is not to be mixed with the rest of the structure at depth 0.

In order for our proof-structures to provide this information, we need to generalize them and consider that a proof-structure can have not just a tree of boxes, but a *forest*: this yields the notion of *quasi-proof-structure* (Definition 1).

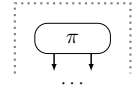

In this way, according to our rewrite rules, opening a box by deleting its principal door amounts to taking a box in the tree and disconnecting it from its root, creating a new tree. We draw this by surrounding elements having the same root with a dashed line, open from the bottom, remembering the phantom presence of the border of the box, below, even if it was erased. This allows one to open the box only when it is “alone” (see Definition 11).

This is not merely a technical remark, as this generalization gives a status to the *mix* rule of LL: indeed, mixing two proofs amounts to taking two proofs and considering them as one, without any other modifications. Here, it amounts to taking two proofs, each with its box-tree, and considering them as one by merging the roots of their trees (see the *mix* step in Definition 11). We embed this design decision up to the level of formulæ, which are segregated in different zones that have to be mixed before interacting (see the notion of partition of a finite sequence of formulæ in Section 3).

Geometric invariance and emptiness: the filled Taylor expansion The use of forests instead of trees for the nesting structure of boxes, where the different roots are thought of as the contents of long-gone boxes, has an interesting consequence in the Taylor expansion: indeed, an element of the Taylor expansion of a proof-structure contains an arbitrary number of copies of the contents of the boxes, in particular *zero*. If we think of the part at depth 0 of a MELL proof-structure as inside an invisible box, its content can be deleted in some elements of the Taylor expansion just as any other box.⁴ As erasing completely conclusions

⁴ The dual case, of copying the contents of a box, poses no problem in our approach.

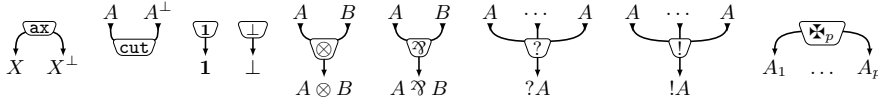

■ **Figure 1** Cells, with their labels and their typed inputs and outputs (ordered from left to right).

would cause the Taylor expansion not preserve the conclusions (which would lead to technical complications), we introduce the *filled Taylor expansion* (Definition 8), which contains not only the elements of the usual Taylor expansion, but also elements of the Taylor expansion where one component has been erased and replaced by a \boxtimes -cell (*daimon*), representing a lack of information, apart from the number and types of the conclusions.

Atomic axioms Our paper first focuses on the case where proof-structures are restricted to *atomic axioms*. In Section 7 we sketch how to adapt our method to the non-atomic case.

3 Proof-structures and the Taylor expansion

MELL formulæ and (quasi-)proof-structures Given a countably infinite set of propositional variables X, Y, Z, \dots , MELL *formulæ* are defined by the following inductive grammar:

$$A, B ::= X \mid X^\perp \mid \mathbf{1} \mid \perp \mid A \otimes B \mid A \boxtimes B \mid !A \mid ?A$$

Linear negation is defined via De Morgan laws $\mathbf{1}^\perp = \perp$, $(A \otimes B)^\perp = A^\perp \boxtimes B^\perp$ and $(!A)^\perp = ?A$, so as to be involutive, *i.e.* $A^{\perp\perp} = A$. Given a list $\Gamma = (A_1, \dots, A_m)$ of MELL formulæ, a *partition* of Γ is a list $(\Gamma_1, \dots, \Gamma_n)$ of lists of MELL formulæ such that there are $0 = i_0 < \dots < i_n = m$ with $\Gamma_j = (A_{i_{j-1}+1}, \dots, A_{i_j})$ for all $1 \leq j \leq n$; such a partition of Γ is also denoted by $(A_1, \dots, A_{i_1}; \dots; A_{i_{n-1}+1}, \dots, A_m)$, with lists separated by semi-colons.

We reuse the syntax of proof-structures given in [17] and sketch here its main features. We suppose known definitions of (directed) graph, rooted tree, and morphism of these structures. In what follows we will speak of *tails* in a graph: “hanging” edges with only one vertex. This can be implemented either by adding special vertices or using [2]’s graphs.

If an edge e is incoming in (resp. outgoing from) a vertex v , we say that e is a *input* (resp. *output*) of v . The reflexive-transitive closure of a tree τ is denoted by τ° : the operator $(\cdot)^\circ$ lifts to a functor from the category of trees to the category of directed graphs.

► **Definition 1.** A module M is a (finite) directed graph with:

- vertices v labeled by $\ell(v) \in \{\mathbf{ax}, \mathbf{cut}, \mathbf{1}, \perp, \otimes, \boxtimes, ?, !\} \cup \{\boxtimes_p \mid p \in \mathbb{N}\}$, the type of v ;
- edges e labeled by a MELL formula $\mathbf{c}(e)$, the type of e ;
- an order $<_M$ that is total on the tails of $|M|$ and on the inputs of each vertex of type \boxtimes, \otimes .

Moreover, all the vertices verify the conditions of Figure 1.⁵

A quasi-proof-structure is a triple $R = (|R|, \mathcal{F}, \mathbf{box})$ where:

- $|R|$ is a module with no input tails, called the module of R ;
- \mathcal{F} is a forest of rooted trees with no input tails, called the box-forest of R ;
- $\mathbf{box}: |R| \rightarrow \mathcal{F}^\circ$ is a morphism of directed graphs, the box-function of R , which induces a partial bijection from the inputs of the vertices of type $!$ and the edges in \mathcal{F} , and such that:
 - for any vertices v, v' with an edge from v' to v , if $\mathbf{box}(v) \neq \mathbf{box}(v')$ then $\ell(v) \in \{!, ?\}$.⁶

⁵ Note that there are no conditions on the types of the outputs of vertices of type \boxtimes (*i.e.* of type \boxtimes_p for some $p \in \mathbb{N}$); and the outputs of vertices of type \mathbf{ax} must have *atomic* types.

⁶ Roughly, it says that the border of a box is made of (inputs of) vertices of type $!$ or $?$.

Moreover, for any output tails e_1, e_2, e_3 in $|R|$ which are outputs of the vertices v_1, v_2, v_3 , respectively, if $e_1 <_{|R|} e_2 <_{|R|} e_3$ then it is impossible that $\text{box}(v_1) = \text{box}(v_3) \neq \text{box}(v_2)$.⁷

A quasi-proof-structure $R = (|R|, \mathcal{F}, \text{box})$ is:

1. MELL^{\boxtimes} if all vertices in $|R|$ of type $!$ have exactly one input, and the partial bijection induced by box from the inputs of the vertices of type $!$ in $|R|$ and the edges in \mathcal{F} is total.
 2. MELL if it is MELL^{\boxtimes} and, for every vertex v in $|R|$ of type \boxtimes , one has $\text{box}^{-1}(\text{box}(v)) = \{v\}$ and $\text{box}(v)$ is not a root of the box-forest \mathcal{F} of R .
 3. $\text{DiLL}_0^{\boxtimes}$ if the box-forest \mathcal{F} of R is just a juxtaposition of roots.
 4. DiLL_0 (or resource) if it is $\text{DiLL}_0^{\boxtimes}$ and there is no vertex in $|R|$ of type \boxtimes .
- For the previous systems, a proof-structure is a quasi-proof-structure whose box-forest is a tree.

Our MELL proof-structure (i.e. a MELL quasi-proof-structure that is also a proof-structure) corresponds to the usual notion of MELL proof-structure (as in [8]) except that we also allow the presence of a box filled only by a *daimon* (i.e. a vertex of type \boxtimes). The *empty* (DiLL_0 and MELL) proof-structure—whose module and box-forest are empty graphs—is denoted by ε .

Given a quasi-proof-structure $R = (|R|, \mathcal{F}, \text{box})$, the output tails of $|R|$ are the *conclusions* of R . So, the pre-images of the roots of \mathcal{F} via box partition the conclusions of R in a list of lists of such conclusions. The *type* of R is the list of lists of the types of these conclusions. We often identify the conclusions of R with a finite initial segment of \mathbb{N} .

By definition of graph morphism, two conclusions in two distinct lists in the type of a quasi-proof-structure R are in two distinct connected components of $|R|$; so, if R is not a proof-structure then $|R|$ contains several connected components. Thus, R can be seen as a list of proof-structures, its *components*, one for each root in its box-forest.

A non-root vertex v in the box-forest \mathcal{F} induces a subgraph of \mathcal{F}° of all vertices above it and edges connecting them. The pre-image of this subgraph through box is the *box* of v and the conditions on box in Definition 1 translate the usual nesting condition for LL boxes.

In quasi-proof-structures, we speak of *cells* instead of vertices, and, for a cell of type ℓ , of a ℓ -cell. A \boxtimes -cell is a \boxtimes_p -cell for some $p \in \mathbb{N}$. An *hypothesis cell* is a cell without inputs.

► **Example 2.** The graph in Figure 2 is a MELL quasi-proof-structure. The colored areas represent the pre-images of boxes, and the dashed boxes represent the pre-images of roots.

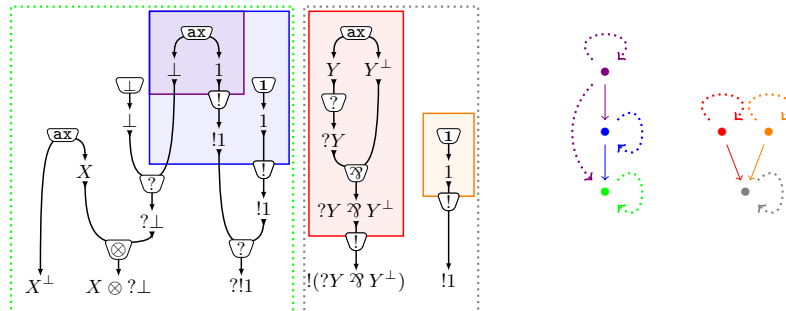

■ **Figure 2** A MELL quasi-proof-structure R , its box-forest \mathcal{F}_R (without dotted lines) and the reflexive-transitive closure \mathcal{F}_R° of \mathcal{F}_R (with also dotted lines).

⁷ This is a technical condition that simplifies the definition of the rewrite rules in Section 4. Note that $\text{box}(v_1), \text{box}(v_2), \text{box}(v_3)$ are necessarily roots in \mathcal{F} , since box is a morphism of directed graphs.

The Taylor expansion Proof-structures have a tree structure made explicit by their box-function. Following [17], the definition of the Taylor expansion uses this tree structure: first, we define how to “*expand*” a tree—and more generally a forest—via a generalization of the notion of thick subtree [3] (Definition 3; roughly, a thick subforest of a box-forest says the number of copies of each box to be taken, iteratively), we then take all the expansions of the tree structure of a proof-structure and we *pull* the approximations *back* to the underlying graphs (Definition 5), finally we *forget* the tree structures associated with them (Definition 6).

► **Definition 3** (thick subforest). *Let τ be a forest of rooted trees. A thick subforest of τ is a pair (σ, h) of a forest σ of rooted trees and a graph morphism $h: \sigma \rightarrow \tau$ whose restriction to the roots of σ is bijective.*

► **Example 4.** The following is a graphical presentation of a thick subforest (τ, h) of the box-forest \mathcal{F} of the quasi-proof-structure in Figure 2, where the graph morphism $h: \tau \rightarrow \mathcal{F}$ is depicted chromatically (same color means same image via h).

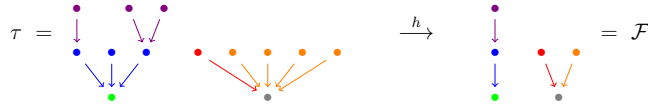

Intuitively, it means that τ is obtained from \mathcal{F} by taking 3 copies of the blue box, 1 copy of the red box and 4 copies of the orange box; in the first (resp. second; third) copy of the blue box, 1 copy (resp. 0 copies; 2 copies) of the purple box has been taken.

► **Definition 5** (proto-Taylor expansion). *Let $R = (|R|, \mathcal{F}_R, \text{box}_R)$ be a quasi-proof-structure. The proto-Taylor expansion of R is the set $\mathcal{T}^{\text{proto}}(R)$ of thick subforests of \mathcal{F}_R .*

Let $t = (\tau_t, h_t) \in \mathcal{T}^{\text{proto}}(R)$. The t -expansion of R is the pullback (R_t, p_t, p_R) below, computed in the category of directed graphs and graph morphisms.

$$\begin{array}{ccc}
 R_t & \xrightarrow{p_t} & \tau_t^\circ \\
 \downarrow p_R & \lrcorner & \downarrow h_t^\circ \\
 |R| & \xrightarrow{\text{box}_R} & \mathcal{F}_R^\circ
 \end{array}$$

Given a quasi-proof-structure R and $t = (\tau_t, h_t) \in \mathcal{T}^{\text{proto}}(R)$, the directed graph R_t inherits labels on vertices and edges by composition with the graph morphism $p_R: R_t \rightarrow |R|$.

Let $[\tau_t]$ be the forest made up of the roots of τ_t and $\iota: \tau_t \rightarrow [\tau_t]$ be the graph morphism sending each vertex of τ_t to the root below it; ι° induces by post-composition a morphism $\bar{h}_t = \iota^\circ \circ p_t: R_t \rightarrow [\tau_t]^\circ$. The triple $(R_t, [\tau_t], \bar{h}_t)$ is a DiLL₀ quasi-proof-structure, and it is a DiLL₀ proof-structure if R is a proof-structure. We can then define the *Taylor expansion* $\mathcal{T}(R)$ of a quasi-proof-structure R (an example of an element of a Taylor expansion is in Figure 3).

► **Definition 6** (Taylor expansion). *Let R be a quasi-proof-structure. The Taylor expansion of R is the set of DiLL₀ quasi-proof-structures $\mathcal{T}(R) = \{(R_t, [\tau_t], \bar{h}_t) \mid t = (\tau_t, h_t) \in \mathcal{T}^{\text{proto}}(R)\}$.*

An element $(R_t, [\tau_t], \bar{h}_t)$ of the Taylor expansion of a quasi-proof-structure R has much less structure than the pullback (R_t, p_t, p_R) : the latter indeed is a DiLL₀ quasi-proof-structure R_t coming with its projections $|R| \xleftarrow{p_R} R_t \xrightarrow{p_t} \tau_t^\circ$, which establish a precise correspondence between cells and edges of R_t and cells and edges of R : a cell in R_t is labeled (via the projections) by both the cell of $|R|$ and the branch of the box-forest of R it arose from. But $(R_t, [\tau_t], \bar{h}_t)$ where R_t is without its projections p_t and p_R loses the correspondence with R .

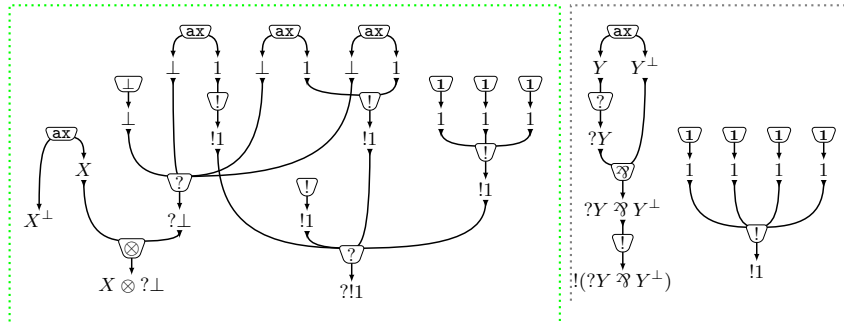

■ **Figure 3** The element of the Taylor expansion of the MELL quasi-proof-structure R in Figure 2, obtained from the element of $\mathcal{T}^{\text{proto}}(R)$ depicted in Example 4.

► **Remark 7.** By definition, the Taylor expansion preserves conclusions: there is a bijection φ from the conclusions of a quasi-proof-structure R to the ones in each element ρ of $\mathcal{T}(R)$ such that i and $\varphi(i)$ have the same type and the same root (i.e. $\text{box}_R(i) = \text{box}_\rho(\varphi(i))$ up to isomorphism). Therefore, the types of R and ρ are the same (as a list of lists).

The filled Taylor expansion As discussed in Section 2 (p. 4), our method needs to “represent” the emptiness introduced by the Taylor expansion (taking 0 copies of a box) so as to preserve the conclusions. So, an element of the *filled Taylor expansion* $\mathcal{T}^{\boxtimes}(R)$ of a quasi-proof-structure R (an example is in Figure 4) is obtained from an element of $\mathcal{T}(R)$ where a whole component can be erased and replaced by a \boxtimes -cell with the same conclusions (hence $\mathcal{T}(R) \subseteq \mathcal{T}^{\boxtimes}(R)$).

► **Definition 8** (filled Taylor expansion). An emptying of a DiLL_0 quasi-proof-structure $\rho = (|\rho|, \mathcal{F}, \text{box})$ is the DiLL_0 quasi-proof-structure with the same conclusions as ρ , obtained from ρ by replacing each of the components of some roots of \mathcal{F} with a \boxtimes -cell whose outputs are tails.

The filled Taylor expansion $\mathcal{T}^{\boxtimes}(R)$ of a quasi-proof-structure R is the set of all the emptyings of every element of its Taylor expansion $\mathcal{T}(R)$.

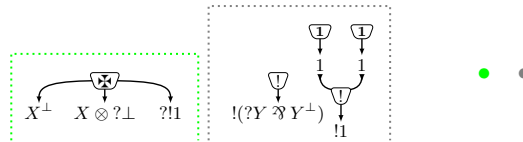

■ **Figure 4** An element of the filled Taylor expansion of the MELL quasi-proof-structure in Figure 2.

4 Means of destruction: unwinding MELL quasi-proof-structures

Our aim is to deconstruct proof-structures (be they MELL^{\boxtimes} or DiLL_0) from their conclusions. To do that, we introduce a category of rules of deconstruction. The morphisms of this category are sequences of deconstructing rules, acting on lists of lists of formulæ. These morphisms act through functors on quasi-proof-structures, exhibiting their sequential structure.

► **Definition 9** (the category **Path**). Let **Path** be the category whose

- objects are lists $\Gamma = (\Gamma_1; \dots; \Gamma_n)$ of lists of MELL formulæ;
- arrows are freely generated by the elementary paths in Figure 5.

We call a path any arrow $\xi: \Gamma \rightarrow \Gamma'$. We write the composition of paths without symbols and in the diagrammatic order, so, if $\xi: \Gamma \rightarrow \Gamma'$ and $\xi': \Gamma' \rightarrow \Gamma''$, $\xi\xi': \Gamma \rightarrow \Gamma''$.

$$\begin{array}{l}
(\Gamma_1; \dots; \Gamma_k, c(i), c(i+1), \Gamma'_k; \dots; \Gamma_n) \xrightarrow{\text{exc}_i} (\Gamma_1; \dots; \Gamma_k, c(i+1), c(i), \Gamma'_k; \dots; \Gamma_n) \\
(\Gamma_1; \dots; \Gamma_k, c(i), c(i+1), \Gamma'_k; \dots; \Gamma_n) \xrightarrow{\text{mix}_i} (\Gamma_1; \dots; \Gamma_k, c(i); c(i+1), \Gamma'_k; \dots; \Gamma_n) \\
(\Gamma_1; \dots; \Gamma_k; c(i), c(i+1); \Gamma_{k+2}; \dots; \Gamma_n) \xrightarrow{\text{ax}_i} (\Gamma_1; \dots; \Gamma_k; \Gamma_{k+2}; \dots; \Gamma_n) \quad \text{with } c(i) = A = c(i+1)^\perp \\
(\Gamma_1; \dots; \Gamma_k; \dots; \Gamma_n) \xrightarrow{\text{cut}^\perp} (\Gamma_1; \dots; \Gamma_k, c(i), c(i+1); \dots; \Gamma_n) \quad \text{with } c(i) = A = c(i+1)^\perp \\
(\Gamma_1; \dots; \Gamma_k; \Gamma_{k+1}, c(i); \Gamma_{k+2}; \dots; \Gamma_n) \xrightarrow{\mathbf{x}_i} (\Gamma_1; \dots; \Gamma_k; \Gamma_{k+2}; \dots; \Gamma_n) \\
(\Gamma_1; \dots; \Gamma_k; c(i); \Gamma_{k+2}; \dots; \Gamma_n) \xrightarrow{\mathbf{1}_i} (\Gamma_1; \dots; \Gamma_k; \Gamma_{k+2}; \dots; \Gamma_n) \quad \text{with } c(i) = \mathbf{1} \\
(\Gamma_1; \dots; \Gamma_k; c(i); \Gamma_{k+2}; \dots; \Gamma_n) \xrightarrow{\perp_i} (\Gamma_1; \dots; \Gamma_k; \Gamma_{k+2}; \dots; \Gamma_n) \quad \text{with } c(i) = \perp \\
(\Gamma_1; \dots; \Gamma_k, c(i); \dots; \Gamma_n) \xrightarrow{\otimes_i} (\Gamma_1; \dots; \Gamma_k, A, B; \dots; \Gamma_n) \quad \text{with } c(i) = A \otimes B \\
(\Gamma_1; \dots; \Gamma_k, c(i); \dots; \Gamma_n) \xrightarrow{\wp_i} (\Gamma_1; \dots; \Gamma_k, A, B; \dots; \Gamma_n) \quad \text{with } c(i) = A \wp B \\
(\Gamma_1; \dots; \Gamma_k, c(i); \dots; \Gamma_n) \xrightarrow{?_i} (\Gamma_1; \dots; \Gamma_k, ?A, ?A; \dots, \Gamma_n) \quad \text{with } c(i) = ?A \\
(\Gamma_1; \dots; \Gamma_k, c(i); \dots; \Gamma_n) \xrightarrow{?_i} (\Gamma_1; \dots; \Gamma_k, A; \dots; \Gamma_n) \quad \text{with } c(i) = ?A \\
(\Gamma_1; \dots; \Gamma_k; c(i); \Gamma_{k+2}; \dots; \Gamma_n) \xrightarrow{?_i} (\Gamma_1; \dots; \Gamma_k; \Gamma_{k+2}; \dots; \Gamma_n) \quad \text{with } c(i) = ?A \\
(\Gamma_1; \dots; ?\Gamma_k, c(i); \dots; \Gamma_n) \xrightarrow{\text{Box}_i} (\Gamma_1; \dots; ?\Gamma_k, A; \dots; \Gamma_n) \quad \text{with } c(i) = !A
\end{array}$$

■ **Figure 5** The generators of **Path**. In the source $\Gamma = (A_1, \dots, A_{i_1}; \dots; A_{i_{m-1}+1}, \dots, A_{i_n})$ of each arrow, $c(i)$ denotes the i^{th} formula in the flattening $(A_1, \dots, A_{i_1}, \dots, A_{i_{m-1}+1}, \dots, A_{i_n})$ of Γ .

► **Example 10.** $\wp_1 \wp_2 \wp_3 \otimes_1 \otimes_3 \text{exc}_1 \text{exc}_2 \text{mix}_2 \text{ax}_1 \text{exc}_2 \text{mix}_2 \text{ax}_1 \text{ax}_1$ is a path of type $((X \otimes Y^\perp) \wp ((Y \otimes Z^\perp) \wp (X^\perp \wp Z))) \longrightarrow \varepsilon$, where ε is the *empty list* of lists of formulæ.

We will tend to forget about exchanges and perform them silently (as it is customary, for instance, in most presentations of sequent calculi).

The category **Path** acts on $\text{MELL}^{\mathbf{x}}$ quasi-proof-structures, exhibiting a sequential structure in their construction. For Γ a list of list of MELL formulæ, $\mathbf{qMELL}^{\mathbf{x}}(\Gamma)$ is the set of $\text{MELL}^{\mathbf{x}}$ quasi-proof-structures of type Γ . To ease the reading of the rewrite rules acting on a $\text{MELL}^{\mathbf{x}}$ quasi-proof-structures R , we will only draw the parts of R belonging to the relevant component; *e.g.*, if we are interested in an ax -cell whose outputs are the conclusions i and

$i+1$, and it is the only cell in a component, we will write $\overset{\text{ax}}{\underbrace{\quad}_i \quad}_{i+1}$ ignoring the rest.

► **Definition 11** (action of paths on MELL quasi-proof-structures). *An elementary path $a: \Gamma \rightarrow \Gamma'$ defines a relation $\mathfrak{a} \subseteq \mathbf{qMELL}^{\mathbf{x}}(\Gamma) \times \mathbf{qMELL}^{\mathbf{x}}(\Gamma')$ (the action of a) as the smallest relation containing all the cases in Figure 6, with the following remarks:*

mix read in reverse, a quasi-proof-structure with two components is in relation with a proof-structure with the same module but the two roots of such components merged.

hypothesis if $a \in \{\text{ax}_i, \mathbf{x}_i, \mathbf{1}_i, \perp_i, ?_w i\}$, the rules have all in common to act by deleting a cell without inputs that is the only cell in its component. We have drawn the axiom case in Figure 6c, the others vary only by their number of conclusions.

cut read in reverse, a quasi-proof-structure with two conclusions i and $i+1$ is in relation with the quasi-proof-structure where these two conclusions are cut. This rule, from left to right, is non-deterministic (as there are many possible cuts).

binary multiplicatives these rules delete a binary connective. We have only drawn the \otimes case in Figure 6e, the \wp case is similar.

contraction splits a $?$ -cell with $h+k+2$ inputs into two $?$ -cells with $h+1$ and $k+1$ inputs, respectively.

dereliction only applies if the $?$ -cell (with 1 input) does not shift a level in the box-forest.

box only applies if a box (and its frontier) is alone in its component.

This definition of the rewrite system is extended to define a relation $\mathfrak{X} \subseteq \mathbf{qMELL}^{\mathbf{x}}(\Gamma) \times \mathbf{qMELL}^{\mathbf{x}}(\Gamma')$ (the action of any path $\xi: \Gamma \rightarrow \Gamma'$) by composition of relations.

23:10 Glueability of resource proof-structures: inverting the Taylor expansion

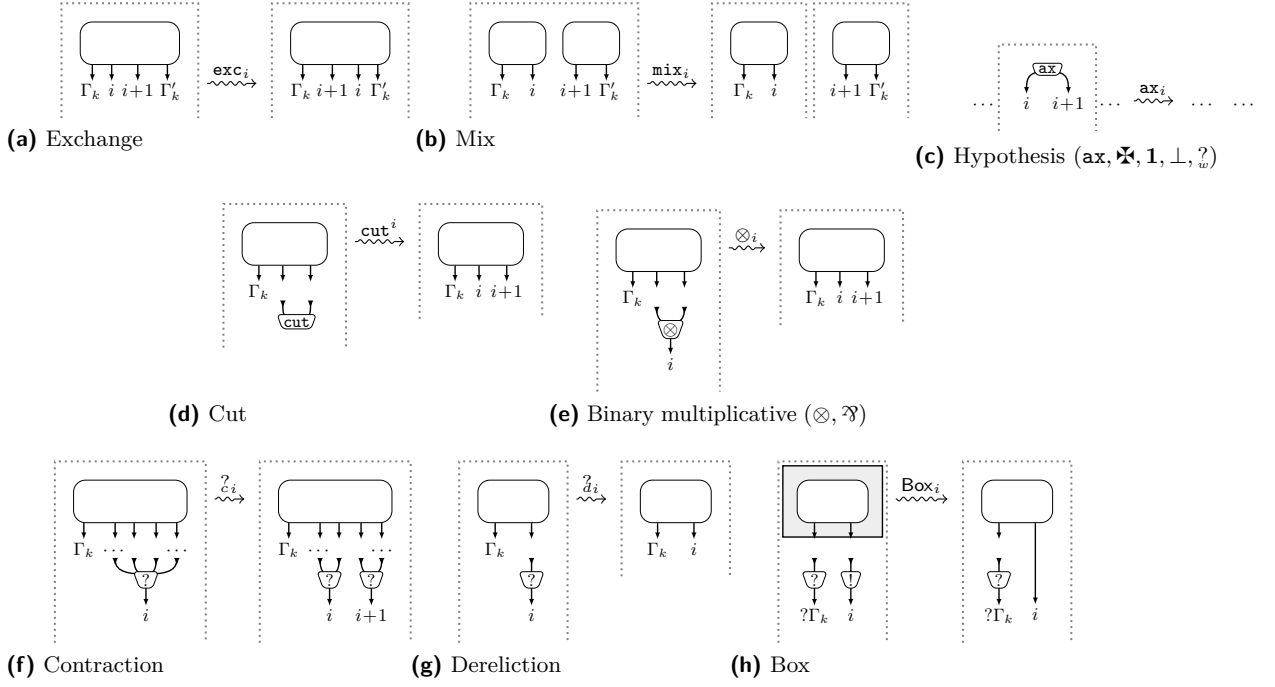

■ **Figure 6** Actions of elementary paths on $\text{MELL}^{\mathfrak{X}}$ quasi-proof-structures.

Given two $\text{MELL}^{\mathfrak{X}}$ quasi-proof-structures R and R' , we say that a rule a applies to R if there is a finite sequence of exchanges $\text{exc}_{i_1} \cdots \text{exc}_{i_n}$ such that $R \xrightarrow{\text{exc}_{i_1} \cdots \text{exc}_{i_n} a} R'$.

- **Definition 12** (the functor $\mathbf{qMELL}^{\mathfrak{X}}$). We define a functor $\mathbf{qMELL}^{\mathfrak{X}}: \text{Path} \rightarrow \text{Rel}$ by:
- on objects: $\mathbf{qMELL}^{\mathfrak{X}}(\Gamma)$ is the set of $\text{MELL}^{\mathfrak{X}}$ quasi-proof-structures of type Γ ;
 - on morphisms: for $\xi: \Gamma \rightarrow \Gamma'$, $\mathbf{qMELL}^{\mathfrak{X}}(\xi) = \xi$ (see Definition 11).

Our rewrite rules enjoy two useful properties, expressed by Propositions 13 and 15.

- **Proposition 13** (co-functionality). Let $\xi: \Gamma \rightarrow \Gamma'$ be a path. The relation ξ is a co-function on the sets of underlying graphs, that is, a function $\xi^{\text{op}}: \mathbf{qMELL}^{\mathfrak{X}}(\Gamma') \rightarrow \mathbf{qMELL}^{\mathfrak{X}}(\Gamma)$.
- **Lemma 14** (applicability of rules). Let R be a non-empty $\text{MELL}^{\mathfrak{X}}$ quasi-proof-structure. There exists a conclusion i such that:
- either a rule in $\{\mathbf{ax}_i, \mathbf{1}_i, \perp_i, \otimes_i, \wp_i, ?_i, ?_i, ?_i, \text{cut}^i, \mathfrak{X}_i, \text{Box}_i\}$ applies to R ;
 - or $R \xrightarrow{\text{mix}_i} R'$ (where the conclusions affected by mix_i are $i-k, \dots, i, i+1, \dots, i+l$) and $i-k, \dots, i$ are all the conclusions of either a box or an hypothesis cell, and one of the components of R' coincides with this cell or box (and its border).

Proposition 13 and Lemma 14 are proven by simple inspection of the rewrite rules of Figure 6.

- **Proposition 15** (termination). Let R be a $\text{MELL}^{\mathfrak{X}}$ quasi-proof-structure of type Γ . There exists a path $\xi: \Gamma \rightarrow \varepsilon$ such that $R \xrightarrow{\xi} \varepsilon$.

To prove Proposition 15, it is enough to apply Lemma 14 and show that the size of $\text{MELL}^{\mathfrak{X}}$ quasi-proof-structures decreases for each application of the rules in Figure 6, according to the following definition of size. The size of a proof-structure R is the couple (p, q) where

- p is the (finite) multiset of the number of inputs of each $?$ -cell in R ;
- q is the number of cells not labeled by \mathfrak{X} in R .

The size of a quasi-proof-structure R is the (finite) multiset of the sizes of its components. Multisets are ordered as usual, couples are ordered lexicographically.

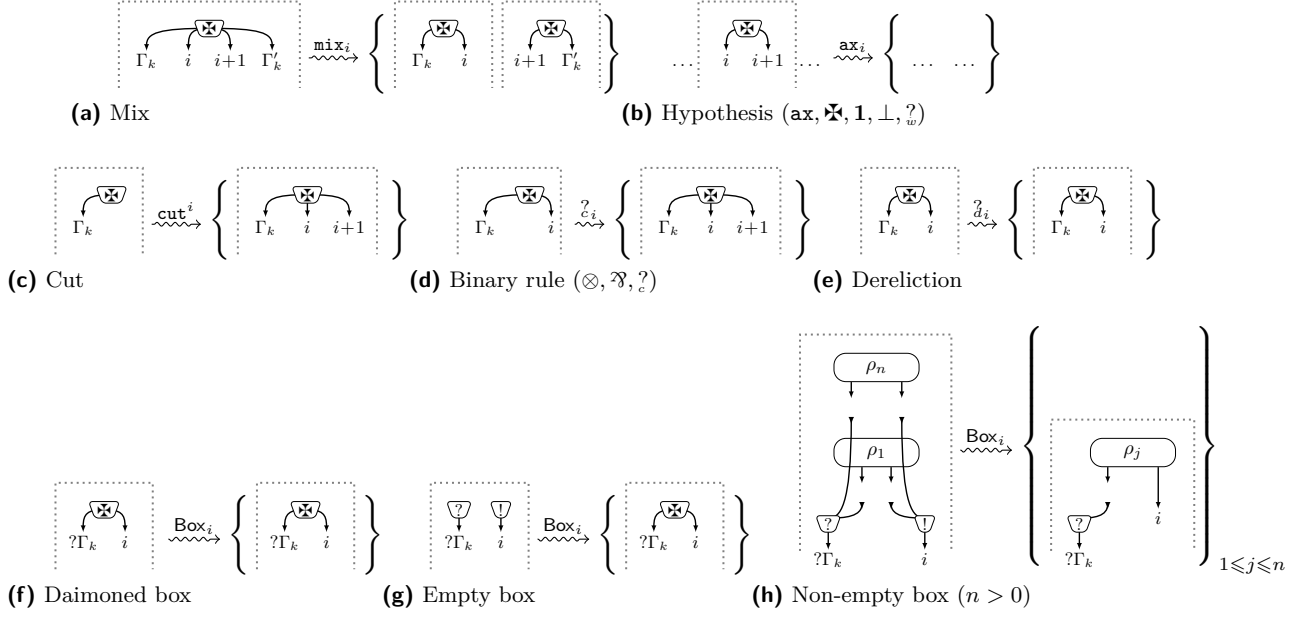

■ **Figure 7** Actions of elementary paths on \mathbf{X} -cells and on a box in $\mathbf{qDiLL}_0^{\mathbf{X}}$.

5 Naturality of unwinding $\mathbf{DiLL}_0^{\mathbf{X}}$ quasi-proof-structures

For Γ a list of lists of MELL formulæ, $\mathbf{qDiLL}_0^{\mathbf{X}}(\Gamma)$ is the set of $\mathbf{DiLL}_0^{\mathbf{X}}$ quasi-proof-structures of type Γ . For any set X , its powerset is denoted by $\mathfrak{P}(X)$.

► **Definition 16** (action of paths on $\mathbf{DiLL}_0^{\mathbf{X}}$ quasi-proof-structures). *An elementary path $a: \Gamma \rightarrow \Gamma'$ defines a relation $\mathfrak{a} \subseteq \mathbf{qDiLL}_0^{\mathbf{X}}(\Gamma) \times \mathfrak{P}(\mathbf{qDiLL}_0^{\mathbf{X}}(\Gamma'))$ (the action of a) by the rules in Figure 6 (except Figure 6h, and with all the already remarked notes) and in Figure 7.*

We extend this relation on $\mathfrak{P}(\mathbf{qDiLL}_0^{\mathbf{X}}(\Gamma)) \times \mathfrak{P}(\mathbf{qDiLL}_0^{\mathbf{X}}(\Gamma'))$ by the monad multiplication of $X \mapsto \mathfrak{P}(X)$ and define $\xi \rightsquigarrow$ (the action of any path $\xi: \Gamma \rightarrow \Gamma'$) by composition of relations.

Roughly, all the rewrite rules in Figure 7—except Figure 7h—mimic the behavior of the corresponding rule in Figure 6 using a \mathbf{X} -cell. Note that in Figure 7g a \mathbf{X} -cell is created.

The non-empty box rule in Figure 7h requires that, on the left of $\overset{\text{Box}_i}{\rightsquigarrow}$, ρ_j is not connected to $\rho_{j'}$ for $j \neq j'$, except for the $!$ -cell and the $?$ -cells in the conclusions. Read in reverse, the rule associates with a non-empty finite set of \mathbf{DiLL}_0 quasi-proof-structures $\{\rho_1, \dots, \rho_n\}$ the merging of ρ_1, \dots, ρ_n , that is the \mathbf{DiLL}_0 quasi-proof-structure depicted on the left of $\overset{\text{Box}_i}{\rightsquigarrow}$.

► **Definition 17** (the functor $\mathfrak{P}\mathbf{qDiLL}_0^{\mathbf{X}}$). *We define a functor $\mathfrak{P}\mathbf{qDiLL}_0^{\mathbf{X}}: \mathbf{Path} \rightarrow \mathbf{Rel}$ by:*

- on objects: for Γ a list of lists of MELL formulæ, $\mathfrak{P}\mathbf{qDiLL}_0^{\mathbf{X}}(\Gamma) = \mathfrak{P}(\mathbf{qDiLL}_0^{\mathbf{X}}(\Gamma))$, the set of sets of $\mathbf{DiLL}_0^{\mathbf{X}}$ proof-structures of type Γ ;
- on morphisms: for $\xi: \Gamma \rightarrow \Gamma'$, $\mathfrak{P}\mathbf{qDiLL}_0^{\mathbf{X}}(\xi) = \xi \rightsquigarrow$ (see Definition 16).

► **Theorem 18** (naturality). *The filled Taylor expansion defines a natural transformation $\mathfrak{T}^{\mathbf{X}}: \mathfrak{P}\mathbf{qDiLL}_0^{\mathbf{X}} \Rightarrow \mathbf{qMELL}^{\mathbf{X}}: \mathbf{Path} \rightarrow \mathbf{Rel}$ by: $(\Pi, R) \in \mathfrak{T}_F^{\mathbf{X}}$ iff $\Pi \subseteq \mathcal{T}^{\mathbf{X}}(R)$ and the type of R is Γ . Moreover, if Π is a set of \mathbf{DiLL}_0 proof-structures with $\Pi \xi \rightsquigarrow \Pi'$ and $\Pi' \subseteq \mathcal{T}(R')$, then R is a MELL proof-structure and $\Pi \subseteq \mathcal{T}(R)$, where R is such that $R \xi \rightsquigarrow R'$.⁸*

Proof in
Appendix A, p. 18

⁸ The part of the statement after “moreover” is our way to control the presence of \mathbf{X} -cells.

23:12 Glueability of resource proof-structures: inverting the Taylor expansion

In other words, the following diagram commutes for every path $\xi: \Gamma \rightarrow \Gamma'$.

$$\begin{array}{ccc} \mathfrak{P}\mathbf{qDiLL}_0^{\mathfrak{X}}(\Gamma) & \xrightarrow{\mathfrak{P}\mathbf{qDiLL}_0^{\mathfrak{X}}(\xi)} & \mathfrak{P}\mathbf{qDiLL}_0^{\mathfrak{X}}(\Gamma') \\ \downarrow \mathfrak{T}_\Gamma^{\mathfrak{X}} & & \downarrow \mathfrak{T}_{\Gamma'}^{\mathfrak{X}} \\ \mathbf{qMELL}^{\mathfrak{X}}(\Gamma) & \xrightarrow{\mathbf{qMELL}^{\mathfrak{X}}(\xi)} & \mathbf{qMELL}^{\mathfrak{X}}(\Gamma') \end{array}$$

It means that given $\Pi \xrightarrow{\xi} \Pi'$, where $\Pi' \subseteq \mathcal{T}^{\mathfrak{X}}(R')$, we can simulate backwards the rewriting to R (this is where the co-functionality of the rewriting steps expressed by Proposition 13 comes handy) so that $R \xrightarrow{\xi} R'$ and $\Pi \subseteq \mathcal{T}^{\mathfrak{X}}(R)$; and conversely, given $R \xrightarrow{\xi} R'$, we can simulate the rewriting for any $\Pi \subseteq \mathcal{T}^{\mathfrak{X}}(R)$, so that $\Pi \xrightarrow{\xi} \Pi'$ for some $\Pi' \subseteq \mathcal{T}^{\mathfrak{X}}(R')$.

6 Glueability of \mathbf{DiLL}_0 quasi-proof-structures

Naturality (Theorem 18) allows us to characterize the sets of \mathbf{DiLL}_0 proof-structures that are in the Taylor expansion of some \mathbf{MELL} proof-structure (Theorem 20 below).

► **Definition 19** (glueability). *We say that a set Π of $\mathbf{DiLL}_0^{\mathfrak{X}}$ quasi-proof-structures is glueable, if there exists a path ξ such that $\Pi \xrightarrow{\xi} \{\varepsilon\}$.*

► **Theorem 20** (glueability criterion). *Let Π be a set of \mathbf{DiLL}_0 proof-structures: Π is glueable if and only if $\Pi \subseteq \mathcal{T}(R)$ for some \mathbf{MELL} proof-structure R .*

Proof. If $\Pi \subseteq \mathcal{T}(R)$ for some \mathbf{MELL} proof-structure R , then by termination (Proposition 15) $R \xrightarrow{\xi} \varepsilon$ for some path ξ , and so $\Pi \xrightarrow{\xi} \{\varepsilon\}$ by naturality (Theorem 18, as $\mathcal{T}^{\mathfrak{X}}(\varepsilon) = \{\varepsilon\}$).

Conversely, if $\Pi \xrightarrow{\xi} \{\varepsilon\}$ for some path ξ , then by naturality (Theorem 18, as $\mathcal{T}(\varepsilon) = \{\varepsilon\}$ and Π is a set of \mathbf{DiLL}_0 proof-structures) $\Pi \subseteq \mathcal{T}(R)$ for some \mathbf{MELL} proof-structure R . ◀

► **Example 21.** The three \mathbf{DiLL}_0 proof-structures ρ_1, ρ_2, ρ_3 below are not glueable as a whole, but are glueable two by two. In fact, there is no \mathbf{MELL} proof-structure whose Taylor expansion contains ρ_1, ρ_2, ρ_3 , but any pair of them is in the Taylor expansion of some \mathbf{MELL} proof-structure. This is a slight variant of the example in [25, pp. 244-246].

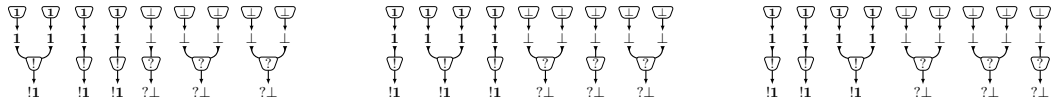

An example of the action of a path starting from a \mathbf{DiLL}_0 proof-structure ρ and ending in $\{\varepsilon\}$ can be found in Figures 8 and 9. Note that it is by no means the shortest possible path. When replayed backwards, it induces a \mathbf{MELL} proof-structure R such that $\rho \in \mathcal{T}(R)$.

7 Non-atomic axioms

From now on, we relax the definition of quasi-proof-structure (Definition 1 and Figure 1) so that the outputs of any **ax**-cell are labeled by dual \mathbf{MELL} formulæ, not necessarily atomic. We can extend our results to this more general setting, with some technical complications. Indeed, the rewrite rule for contraction has to be modified. Consider a set of \mathbf{DiLL}_0 proof-structures consisting of just a singleton which is a \mathfrak{X} -cell. The contraction rule rewrites it as:

$$!A^\perp !A^\perp ?A \xrightarrow{\mathfrak{C}_3} \left\{ !A^\perp !A^\perp ?A ?A \right\} \text{ which is then in the Taylor expansion of } !A^\perp !A^\perp ?A ?A$$

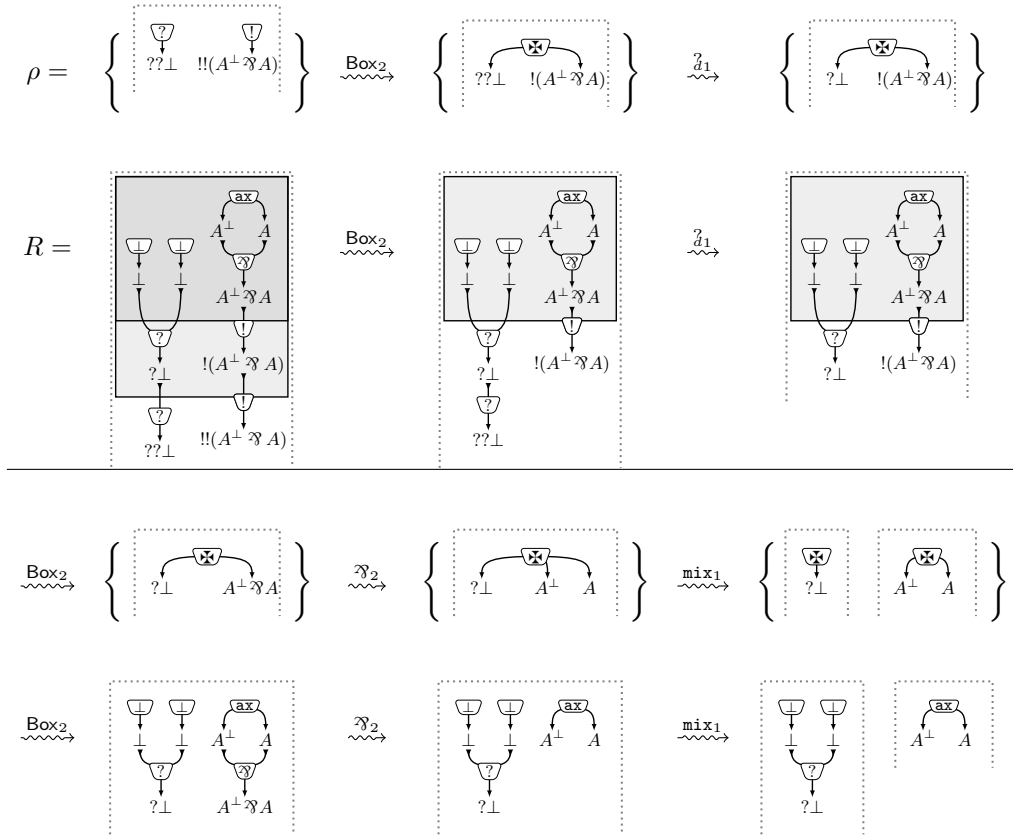

Figure 8 The path $\text{Box}_2 \overset{?d_1}{\rightsquigarrow} \text{Box}_2 \overset{?d_2}{\rightsquigarrow} \text{mix}_1 \text{ax}_{2,3} \overset{?c_1}{\rightsquigarrow} \overset{?d_2}{\rightsquigarrow} \text{mix}_1 \perp_2 \overset{?d_1}{\rightsquigarrow} \perp_1$ witnessing that $\rho \in \mathcal{T}(R)$ (to be continued on Figure 9).

on which no contraction rewrite rule $?$ can be applied backwards, breaking the naturality. The failure of the naturality is actually due to the failure of Proposition 13 in the case of the rewrite rule $?: \overset{?c_1}{\rightsquigarrow} \overset{?d_2}{\rightsquigarrow} \text{op}$ (i.e. $\overset{?c_1}{\rightsquigarrow} \overset{?d_2}{\rightsquigarrow}$ read from the right to the left) is functional but not total.

The solution to this conundrum lies in changing the contraction rule for $\text{DiLL}_0^{\boxtimes}$ quasi-proof-structures, by explicitly adding $?$ -cells. Hence, the application of a contraction step $?$ in the $\text{DiLL}_0^{\boxtimes}$ quasi-proof-structures precludes the possibility of anything else but a $?$ -cell on the MELL^{\boxtimes} side, which allows the contraction step $?$ to be applied backwards.

In turn, this forces us to change the definition of the filled Taylor expansion into a η -filled Taylor expansion, which has to include elements where a \boxtimes -cell (representing an empty component) has some of its outputs connected to $?$ -cells.

► **Definition 22** (η -filled Taylor expansion). An η -emptying of a DiLL_0 quasi-proof-structure $\rho = (|\rho|, \mathcal{F}, \text{box})$ is a DiLL_0 quasi-proof-structure with the same conclusions as ρ , obtained from ρ by replacing each of the components of some roots of \mathcal{F} with a \boxtimes -cell whose outputs are either tails or inputs of a $?$ -cell whose output i is a tail, provided that i is the output tail of a $?$ -cell in ρ .

The η -filled Taylor expansion $\mathcal{T}_\eta^{\boxtimes}(R)$ of a quasi-proof-structure R is the set of all the η -emptyings of every element of its Taylor expansion $\mathcal{T}(R)$.

Note that the η -filled Taylor expansion contains all the elements of the filled Taylor expansion and some more, such as the one in Figure 10.

23:14 Glueability of resource proof-structures: inverting the Taylor expansion

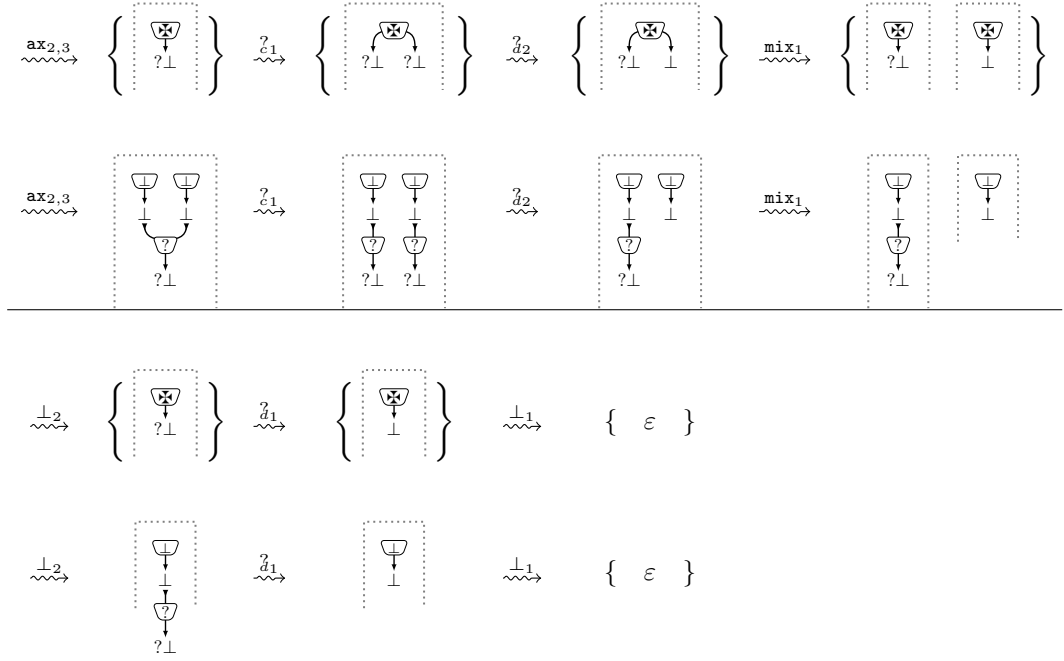

■ **Figure 9** The path $\text{Box}_2 \ ?_{d_1} \ \text{Box}_2 \ \text{?}_{d_2} \ \text{mix}_1 \ \text{ax}_{2,3} \ ?_{c_1} \ ?_{d_2} \ \text{mix}_1 \ \perp_2 \ ?_{d_1} \ \perp_1$ witnessing that $\rho \in \mathcal{T}(R)$ (continued from Figure 8).

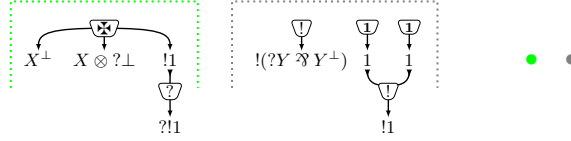

■ **Figure 10** An element of the η -filled Taylor expansion of the MELL quasi-proof-structure in Fig. 2.

Functors \mathbf{qMELL}^\boxtimes and $\mathfrak{P}\mathbf{qDiLL}_0^\boxtimes$ are defined as before (Def. 12 and 17, respectively),⁹ except that the image of $\mathfrak{P}\mathbf{qDiLL}_0^\boxtimes$ on the generator $?_{c_i}$ (Figure 7d) is changed to

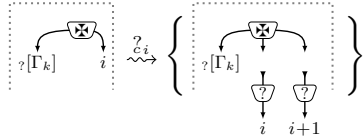

where $?[\Gamma_k]$ signifies that some of the conclusions of Γ_k might be connected to the \boxtimes -cell through a $?$ -cell (see Appendix B for details). We can prove similarly our main results.

► **Theorem 23** (naturality with η). *The η -filled Taylor expansion defines a natural transformation $\mathfrak{T}_\eta^\boxtimes: \mathfrak{P}\mathbf{qDiLL}_0^\boxtimes \Rightarrow \mathbf{qMELL}^\boxtimes: \mathbf{Path} \rightarrow \mathbf{Rel}$ by: $(\Pi, R) \in \mathfrak{T}_\eta^\boxtimes \Gamma$ iff $\Pi \subseteq \mathcal{T}_\eta^\boxtimes(R)$ and the type of R is Γ . Moreover, if Π is a set of \mathbf{DiLL}_0 proof-structures with $\Pi \xrightarrow{\xi} \Pi'$ and $\Pi' \subseteq \mathcal{T}(R')$, then R is a MELL proof-structure and $\Pi \subseteq \mathcal{T}(R)$, where R is such that $R \xrightarrow{\xi} R'$.*

► **Theorem 24** (glueability criterion with η). *Let Π be a set of \mathbf{DiLL}_0 proof-structures, not necessarily with atomic axioms: Π is glueable iff $\Pi \subseteq \mathcal{T}(R)$ for some MELL proof-structure R .*

⁹ Remember that now, for Γ a list of list of MELL formulæ, $\mathbf{qMELL}^\boxtimes(\Gamma)$ (resp. $\mathbf{qDiLL}_0^\boxtimes(\Gamma)$) is the set of MELL ^{\boxtimes} (resp. $\mathbf{DiLL}_0^\boxtimes$) quasi-proof-structures of type Γ , possibly with non-atomic axioms.

8 Conclusions and perspectives

✕-cells inside boxes Our glueability criterion (Theorem 20) solves the inverse Taylor expansion problem in a “asymmetric” way: we characterize the sets of DiLL_0 proof-structures that are included in the Taylor expansion of some MELL proof-structure, but DiLL_0 proof-structures have no occurrences of ✕-cells, while a MELL proof-structure possibly contains ✕-cells inside boxes (see Definition 1). Not only this asymmetry is technically inevitable, but it reflects on the fact that some glueable set of DiLL_0 proof-structure might not contain any information on the content of some box (which is reified in MELL by a ✕-cell), or worse that, given the types, no content can fill that box. Think of the DiLL_0 proof-structure ρ made only of a !-cell with no inputs and one output of type $!X$, where X is atomic: $\{\rho\}$ is glueable but the only MELL proof-structure R such that $\{\rho\} \subseteq \mathcal{T}(R)$ is made of a box containing a ✕-cell.

This asymmetry is also present in Pagani and Tasson’s characterization [22], even if not particularly emphasized: their Theorem 2 (analogous to the left-to-right part of our Theorem 20) assumes not only that the rewriting starting from a finite set of DiLL_0 proof-structures terminates but also that it ends on a MELL proof-structure (without ✕-cells, which ensures that there exists a MELL proof-structure without ✕-cells filling all the empty boxes).

The λ -calculus, connectedness and coherence Our rewriting system and glueability criterion should help to prove the existence of a binary coherence for elements of the Taylor expansion of a fragment of MELL proof-structures (despite the impossibility for full MELL proved in [25]), extending the one that exists for resource λ -terms. We can remark that our glueability criterion is actually an extension of the criterion for resource λ -terms. Indeed, in the case of the λ -calculus, there are three rewrite steps, corresponding to abstraction, application and variable (which can be encoded in our rewrite steps), and coherence is defined inductively: if a set of resource λ -terms is coherent, then any set of resource λ -term that rewrites to it is also coherent.

Presented in this way, the main difference between the λ -calculus and MELL (concerning the inverse Taylor expansion problem) would not be because of the rewriting system but because the structure of any resource λ -term univocally determines the rewriting path, while, for DiLL_0 proof-structures, we have to quantify existentially over all possible paths. This is an unavoidable consequence of the fact that proof-structures do not have a tree-structure, contrary to λ -terms and resource λ -terms.

Moreover, it is possible to match and mix different sequences of rewriting. Indeed, consider three DiLL_0 proof-structures pairwise glueable. Proving that they are glueable as a whole amounts to computing a rewriting path from the rewriting paths witnessing the three glueabilities. Our paths were designed with that mixing-and-matching operation in mind, in the particular case where the boxes are connected. This is reminiscent of [16], where we also showed that a certain property enjoyed by the λ -calculus can be extended to proof-structures, provided they are connected inside boxes. We leave that work to a subsequent paper.

Functoriality and naturality Our functorial point of view on proof-structures might unify many results. Let us cite two of them:

- a sequent calculus proof of $\vdash \Gamma$ can be translated into a path from the empty sequence into Γ . This could be the starting point for the formulation of a new correctness criterion;
- the category **Path** can be extended with higher structure, allowing to represent cut-elimination. The functors \mathbf{qMELL}^{\times} and $\mathfrak{P}\mathbf{qDiLL}_0^{\times}$ can also be extended to such higher functors, proving via naturality that cut-elimination and the Taylor expansion commute.

Acknowledgments This work has been partially funded by the EPSRC grant EP/R029121/1 “Typed Lambda-Calculi with Sharing and Unsharing” and the ANR project Rapido (ANR-14-CE35-0007).

References

- 1 Denis B echet. Minimality of the correctness criterion for multiplicative proof nets. *Mathematical Structures in Computer Science*, 8(6):543–558, 1998.
- 2 Dennis V. Borisov and Yuri I. Manin. *Generalized Operads and Their Inner Cohomomorphisms*, volume 265 of *Progress in Mathematics*, pages 247–308. Birkh user Basel, Basel, 2007. doi:10.1007/978-3-7643-8608-5_4.
- 3 Pierre Boudes. Thick subtrees, games and experiments. In *Typed Lambda Calculi and Applications, 9th International Conference (TLCA 2009)*, volume 5608 of *Lecture Notes in Computer Science*, pages 65–79. Springer, 2009. doi:10.1007/978-3-642-02273-9_7.
- 4 Pierre Boudes, Fanny He, and Michele Pagani. A characterization of the Taylor expansion of lambda-terms. In *Computer Science Logic 2013 (CSL 2013)*, volume 23 of *LIPICs*, pages 101–115. Schloss Dagstuhl - Leibniz-Zentrum fuer Informatik, 2013. doi:10.4230/LIPICs.CSL.2013.101.
- 5 G erard Boudol. The lambda-calculus with multiplicities (abstract). In *4th International Conference on Concurrency Theory (CONCUR ’93)*, volume 715 of *Lecture Notes in Computer Science*, pages 1–6. Springer, 1993. doi:10.1007/3-540-57208-2_1.
- 6 Daniel de Carvalho. The relational model is injective for multiplicative exponential linear logic. In *25th Annual Conference on Computer Science Logic (CSL 2016)*, volume 62 of *LIPICs*, pages 41:1–41:19. Schloss Dagstuhl - Leibniz-Zentrum fuer Informatik, 2016. doi:10.4230/LIPICs.CSL.2016.41.
- 7 Daniel de Carvalho. Taylor expansion in linear logic is invertible. *Logical Methods in Computer Science*, 14(4), 2018. doi:10.23638/LMCS-14(4:21)2018.
- 8 Daniel de Carvalho and Lorenzo Tortora de Falco. The relational model is injective for multiplicative exponential linear logic (without weakenings). *Annals of Pure and Applied Logic*, 163(9):1210–1236, 2012. doi:10.1016/j.apal.2012.01.004.
- 9 Thomas Ehrhard. On K othe sequence spaces and linear logic. *Mathematical Structures in Computer Science*, 12(5):579–623, 2002. doi:10.1017/S0960129502003729.
- 10 Thomas Ehrhard. Finiteness spaces. *Mathematical Structures in Computer Science*, 15(4):615–646, 2005. doi:10.1017/S0960129504004645.
- 11 Thomas Ehrhard and Laurent Regnier. The differential lambda-calculus. *Theoretical Computer Science*, 309(1-3):1–41, 2003. doi:10.1016/S0304-3975(03)00392-X.
- 12 Thomas Ehrhard and Laurent Regnier. B ohm Trees, Krivine’s Machine and the Taylor Expansion of Lambda-Terms. In *Second Conference on Computability in Europe (CiE 2006)*, volume 3988 of *Lecture Notes in Computer Science*, pages 186–197. Springer, 2006. doi:10.1007/11780342_20.
- 13 Thomas Ehrhard and Laurent Regnier. Differential interaction nets. *Theoretical Computer Science*, 364(2):166–195, 2006. doi:10.1016/j.tcs.2006.08.003.
- 14 Thomas Ehrhard and Laurent Regnier. Uniformity and the Taylor expansion of ordinary lambda-terms. *Theoretical Computer Science*, 403(2-3):347–372, 2008. doi:10.1016/j.tcs.2008.06.001.
- 15 Jean-Yves Girard. Linear logic. *Theoretical Computer Science*, 50(1):1–101, 1987. doi:10.1016/0304-3975(87)90045-4.
- 16 Giulio Guerrieri, Luc Pellissier, and Lorenzo Tortora de Falco. Computing connected proof(-structure)s from their Taylor expansion. In *1st International Conference on Formal Structures for Computation and Deduction (FSCD 2016)*, volume 52 of *LIPICs*, pages 20:1–20:18. Schloss Dagstuhl - Leibniz-Zentrum fuer Informatik, 2016. doi:10.4230/LIPICs.FSCD.2016.20.

- 17 Giulio Guerrieri, Luc Pellissier, and Lorenzo Tortora de Falco. Proof-net as graph, Taylor expansion as pullback. In *Logic, Language, Information, and Computation - 26th International Workshop (WoLLIC 2019)*, volume 11541 of *Lecture Notes in Computer Science*, pages 282–300. Springer, 2019. doi:10.1007/978-3-662-59533-6_18.
- 18 Emma Kerinec, Giulio Manzonetto, and Michele Pagani. Revisiting call-by-value Böhm trees in light of their Taylor expansion. *CoRR*, abs/1809.02659, 2018. URL: <http://arxiv.org/abs/1809.02659>.
- 19 Giulio Manzonetto and Domenico Ruoppolo. Relational graph models, Taylor expansion and extensionality. *Electronic Notes in Theoretical Computer Science*, 308:245–272, 2014. doi:10.1016/j.entcs.2014.10.014.
- 20 Damiano Mazza and Michele Pagani. The separation theorem for differential interaction nets. In *Logic for Programming, Artificial Intelligence, and Reasoning, 14th International Conference (LPAR 2007)*, volume 4790 of *Lecture Notes in Computer Science*, pages 393–407. Springer, 2007. doi:10.1007/978-3-540-75560-9_29.
- 21 Damiano Mazza, Luc Pellissier, and Pierre Vial. Polyadic approximations, fibrations and intersection types. *PACMPL*, 2(POPL):6:1–6:28, 2018. doi:10.1145/3158094.
- 22 Michele Pagani and Christine Tasson. The inverse Taylor expansion problem in linear logic. In *24th Annual Symposium on Logic in Computer Science (LICS 2009)*, pages 222–231. IEEE Computer Society, 2009. doi:10.1109/LICS.2009.35.
- 23 Michele Pagani, Christine Tasson, and Lionel Vaux. Strong normalizability as a finiteness structure via the Taylor expansion of λ -terms. In *Foundations of Software Science and Computation Structures - 19th International Conference (FOSSACS 2016)*, volume 9634 of *Lecture Notes in Computer Science*, pages 408–423. Springer, 2016. doi:10.1007/978-3-662-49630-5_24.
- 24 Christian Retoré. A semantic characterisation of the correctness of a proof net. *Mathematical Structures in Computer Science*, 7(5):445–452, 1997. doi:10.1017/S096012959700234X.
- 25 Christine Tasson. *Sémantiques et Syntaxes Vectorielles de la Logique Linéaire*. PhD thesis, Université Paris Diderot, France, December 2009. URL: <https://tel.archives-ouvertes.fr/tel-00440752>.
- 26 Lionel Vaux. Taylor expansion, lambda-reduction and normalization. In *26th EACSL Annual Conference on Computer Science Logic (CSL 2017)*, volume 82 of *LIPICs*, pages 39:1–39:16. Schloss Dagstuhl - Leibniz-Zentrum fuer Informatik, 2017. doi:10.4230/LIPICs.CSL.2017.39.

Technical Appendix

A Proof of naturality (Theorem 18, p. 11)

\mathfrak{T}^{\boxtimes} is a family of morphisms of **Rel** indexed by the objects in **Path**. In the first part of the statement (before “Moreover”), the only thing to show is that the naturality squares

$$\begin{array}{ccc}
 \mathfrak{P}\mathbf{qDiLL}_0^{\boxtimes}(\Gamma) & \xrightarrow{\mathfrak{P}\mathbf{qDiLL}_0^{\boxtimes}(\xi)} & \mathfrak{P}\mathbf{qDiLL}_0^{\boxtimes}(\Gamma') \\
 \downarrow \mathfrak{T}_\Gamma^{\boxtimes} & & \downarrow \mathfrak{T}_{\Gamma'}^{\boxtimes} \\
 \mathbf{qMELL}^{\boxtimes}(\Gamma) & \xrightarrow{\mathbf{qMELL}^{\boxtimes}(\xi)} & \mathbf{qMELL}^{\boxtimes}(\Gamma')
 \end{array}$$

commute for every path $\xi : \Gamma \rightarrow \Gamma'$, and actually, it is enough to show that such squares commute for all elementary paths. Let $a : \Gamma \rightarrow \Gamma'$ be an elementary path.

1. $\mathbf{qMELL}^{\boxtimes}(a) \circ \mathfrak{T}_\Gamma^{\boxtimes} \subseteq \mathfrak{T}_{\Gamma'}^{\boxtimes} \circ \mathfrak{P}\mathbf{qDiLL}_0^{\boxtimes}(a)$.

Let $(\Pi, R') \in \mathbf{qMELL}^{\boxtimes}(a) \circ \mathfrak{T}_\Gamma^{\boxtimes}$. Let $R \in \mathbf{qMELL}^{\boxtimes}(\Gamma)$ be a witness of composition, that is an element such that $(\Pi, R) \in \mathfrak{T}_\Gamma^{\boxtimes}$ and $R \rightsquigarrow R'$.

Let $p : t \rightarrow \mathcal{F}$ be a thick subforest of \mathcal{F} , let r_1, \dots, r_n be some roots of \mathcal{F} , and let $\rho_{r_1 \dots r_n} \in \Pi$ be the element of the filled Taylor expansion of R associated with p and r_1, \dots, r_n .

- If $a = \mathbf{mix}_i$, then, in R , the conclusions $1, \dots, i, i+1, \dots, k$ are exactly the conclusions of a root in the box-forest of R , and the connected components in R of i and $i+1$ are disjoint. By Definitions 6 and 8, since $\rho_{r_1 \dots r_n} \in \Pi \subseteq \mathcal{T}^{\boxtimes}(R)$, we have that the conclusions $1, \dots, i, i+1, \dots, k$ are exactly the conclusions of a root r in the box-forest of $\rho_{r_1 \dots r_n}$, and we have two possibilities:
 - the connected components of i and $i+1$ are disjoint in $\rho_{r_1 \dots r_n}$;
 - i and $i+1$ belong to the same connected component, in which case $r \in \{r_1, \dots, r_n\}$ and $\rho_{r_1 \dots r_n}$ is a \boxtimes -cell with conclusion $1, \dots, i, i+1, \dots, k$.

In both cases the rule \mathbf{mix}_i is also applicable in $\rho_{r_1 \dots r_n}$, yielding a \mathbf{DiLL}_0 proof-structure ρ' . The box-forest \mathcal{F}' of R' is obtained from the box-forest \mathcal{F} of R by replacing a root b by two roots b_1, b_2 . Let $p' : t' \rightarrow \mathcal{F}'$ be such that all the boxes $d \neq b_1, b_2$ have the same inverse image than by p : $p'^{-1}(d) = p^{-1}(d)$, and, $p'^{-1}(b_1) = p^{-1}(b) \times \{1\}$, $p'^{-1}(b_2) = p^{-1}(b) \times \{2\}$. We verify that ρ' is the filled Taylor expansion of R' through p' .

- If $a \in \{\mathbf{ax}_i, \boxtimes_i, \mathbf{1}_i, \perp_i, \mathbf{?}_{w_i}\}$, let k be such that the rule a acts on the conclusions $i, \dots, i+k$ in R , and let ℓ be the type of the cell in R connected to the conclusions $i, \dots, i+k$. In $\rho_{r_1 \dots r_n}$ there is a cell of type ℓ or \boxtimes connected to the same conclusions. Clearly a is applicable to $\rho_{r_1 \dots r_n}$, which yields a \mathbf{DiLL}_0 proof-structure ρ' .

The box-forest \mathcal{F}' of R' is obtained from the box-forest \mathcal{F} of R by erasing a root b . Let $p' : t' \rightarrow \mathcal{F}'$ be such that all the boxes $d \neq b$ have the same inverse image than by p : $p'^{-1}(d) = p^{-1}(d)$. We verify that ρ' is the filled Taylor expansion of R' through p' .

- If $a \in \{\otimes_i, \mathfrak{P}_i, \mathbf{?}_{d_i}, \mathbf{?}_{c_i}\}$, let k be such that the rule a acts on the conclusions $i, \dots, i+k$ in R , and let ℓ be the type of the cell in R connected to the conclusions $i, \dots, i+k$. In $\rho_{r_1 \dots r_n}$ there is a cell of type ℓ or \boxtimes connected to the same conclusions. Clearly a is applicable to $\rho_{r_1 \dots r_n}$, which yields a \mathbf{DiLL}_0 proof-structure ρ' .

R' has the same box-forest \mathcal{F} as R . We verify that ρ' is the expansion of R' through p .

- If $a = \text{cut}^i$, let c be the cut-cell in R to which the rule is applied. The cut-cell c has either one image in $\rho_{r_1 \dots r_n}$ or is represented by a \boxtimes cell. In both cases, cut^i is applicable to $\rho_{r_1 \dots r_n}$, yielding ρ' .

R' has the same box-forest \mathcal{F} as R . We verify that ρ' is the expansion of R' through p .

- If $a = \text{Box}_i$, let k be such that the rule a acts on the conclusions $i, \dots, i+k$ in R . In $\rho_{r_1 \dots r_n}$ we have one of the following possibilities:
 - $\rho_{r_1 \dots r_n}$ consists of a unique \boxtimes -cell with the same conclusions $i, \dots, i+k$;
 - $\rho_{r_1 \dots r_n}$ consists of a !-cell in i with no premises and k ?-cells with no premises above the other k conclusions;
 - there is a !-cell above the conclusion i and a ?-cell above each of the other k conclusions; and the other cells of this root can be identified by their image $1, \dots, \ell$ in t : we have ℓ pairwise disconnected sub-proof-structures π_1, \dots, π_ℓ .

In any case, the rule Box_i can be applied, yielding either a family $\rho'_1, \dots, \rho'_\ell$ of $\text{DiLL}_0^{\boxtimes}$ proof-structures or a $\text{DiLL}_0^{\boxtimes}$ proof-structure ρ'_1 . More precisely, in the first (resp. second, third) case, we apply the Daimoned (resp. Empty, Non-empty) box rule (see Figure 7(g), 7(h), 7(i)).

The box-forest \mathcal{F}' of R' is obtained from the box-forest \mathcal{F} of R by erasing the root of the conclusions $i, \dots, i+k$: the new root b' of this tree of \mathcal{F}' is the unique vertex connected to the root of \mathcal{F} (its unique son). We have $p^{-1}(b') = \{b'_1, \dots, b'_\ell\}$, and ℓ trees t'_1, \dots, t'_ℓ , where b'_i is the root of t'_i . The morphisms $p'_i : t'_i \rightarrow \mathcal{F}'$ are defined accordingly, and ρ'_i is the filled Taylor expansion of R through p'_i .

2. $\mathfrak{T}_\Gamma^{\boxtimes} \circ \mathfrak{PqDiLL}_0^{\boxtimes}(a) \subseteq \mathfrak{qMELL}^{\boxtimes}(a) \circ \mathfrak{T}_\Gamma^{\boxtimes}$.

Let $(\Pi, R') \in \mathfrak{T}_\Gamma^{\boxtimes} \circ \mathfrak{PqDiLL}_0^{\boxtimes}(a)$. Let Π' be a witness of composition, that is a set of $\mathfrak{PqDiLL}_0^{\boxtimes}(\Gamma')$ such that $(\Pi, \Pi') \in \mathfrak{PqDiLL}_0^{\boxtimes}(a)$ and $(\Pi', R') \in \mathfrak{T}_\Gamma^{\boxtimes}$.

We want to exhibit a MELL^{\boxtimes} quasi-proof-structure R such that $R \rightsquigarrow R'$ and Π is a part of the filled Taylor expansion of R . By co-functionality of $\mathfrak{qMELL}^{\boxtimes}(a)$ (Proposition 13), we have a candidate for such an R : the pre-image of R' by this co-functional relation. We only have to check that R' is in the image of the co-functional relation and that Π is a part of the filled Taylor expansion of the pre-image R of R' by the co-functional relation. In other terms: if $a : \Gamma \rightarrow \Gamma'$ and $R' \in \mathfrak{qMELL}^{\boxtimes}(\Gamma')$, then there exists $R \in \mathfrak{qMELL}^{\boxtimes}(\Gamma)$ such that $R \rightsquigarrow R'$ and $\Pi \subseteq \mathcal{T}^{\boxtimes}(R)$.

- If $a \neq ?_i$, there exists (a unique) $R \in \mathfrak{qMELL}^{\boxtimes}(\Gamma)$ such that $R \rightsquigarrow R'$. The case $a = ?_i$ is a bit more delicate: in this case too there exists (a unique) $R \in \mathfrak{qMELL}^{\boxtimes}(\Gamma)$ such that $R \rightsquigarrow R'$, but here we use the fact that the types of the axiom conclusions are atomic. Indeed, thanks to this choice every conclusion of R' of type $?A$ is the conclusion of a ?-cell (or of a \boxtimes -cell).

- Let R be the unique pre-image of R' through $\mathfrak{qMELL}^{\boxtimes}(a)$ ($R = \rightsquigarrow^{\text{op}}(R')$). We need to show that Π is a part of the filled Taylor expansion of R . Let $\rho \in \Pi$ and $\{\rho'_1, \dots, \rho'_n\} \subseteq \Pi'$ such that $\rho \rightsquigarrow \{\rho'_1, \dots, \rho'_n\}$. In all cases except Box , this set is a singleton $\{\rho'_1\}$. In that cases, let $p' : t' \rightarrow \mathcal{F}'$ and r'_1, \dots, r'_k be the conclusions of R' such that $\rho'_1 = \rho_{r'_1 \dots r'_k}$ is the element of the filled Taylor expansion of R' associated with p' and r'_1, \dots, r'_k .

If $a \in \{\text{ax}_i, \boxtimes_i, \mathbf{1}_i, \perp_i, ?_{wi}\}$, let r be the root of the conclusion i in R and let s be the root of the conclusion i in ρ . \mathcal{F} is the disjoint union of \mathcal{F}' and the root r . Let t be the disjoint union of t' and the root s , and $p : t \rightarrow \mathcal{F}$ be defined as p' over t' and $p(s) = r$. If the cell rooted in i in ρ is a \boxtimes , then we check that ρ is the element of the filled

Taylor expansion of R associated with p and r, r'_1, \dots, r'_k , else associated with p and r'_1, \dots, r'_k .

If $a \in \{\text{cut}_i^i, \otimes_i, \wp_i, ?_d^i, ?_c^i\}$, then $\mathcal{F} = \mathcal{F}'$, $p = p'$ and we check that ρ is the element of the filled Taylor expansion of R associated with p and r'_1, \dots, r'_k .

If $a = \text{mix}_i$, let r'_1 and r'_2 be the respective roots of the conclusion i and $i+k$ in R' , and let r be the root of the conclusion i in R . Consider the roots s'_1 and s'_2 in t' such that i is produced from s'_1 and $i+k$ from s'_2 , let t be equal to t' except that the two roots s'_1 and s'_2 are merged and change p' into p accordingly. We check that ρ is the element of the filled Taylor expansion of R associated with p and r'_1, \dots, r'_k .

If $a = \text{Box}_i$, we describe the case of the Non-empty box rule (Figure 7(i)), leaving the two easier cases of the Daimonded (resp. Empty) box rule of Figure 7(g) (resp. Figure 7(h)) to the reader.

Let $p'_1 : t'_1 \rightarrow \mathcal{F}', \dots, p'_n : t'_n \rightarrow \mathcal{F}'$ be such that ρ'_1, \dots, ρ'_n are the expansions of R' associated with, respectively, p'_1, \dots, p'_n . The forests t'_1, \dots, t'_n differ by only one tree. Consider the forest t which has all the trees on which the n forests do not differ and the union of the trees on which the forests differ, all connected with a root, and define p accordingly. We check that ρ is the element of the filled Taylor expansion of R associated with p and r'_1, \dots, r'_k .

Concerning the second part of the statement of Theorem 18 (after “Moreover”), we prove the following stronger statement: given two sets Π and Π' of $\text{DiLL}_0^{\boxtimes}$ quasi-proof-structures and a MELL^{\boxtimes} quasi-proof-structure R' ,

1. if $\Pi \rightsquigarrow \Pi'$ and $\Pi' \subseteq \mathcal{T}(R')$, then $\Pi \subseteq \mathcal{T}(R)$ where R is such that $R \rightsquigarrow R'$;
2. if moreover Π is a set of DiLL_0 proof-structures, then R is a MELL proof-structure.

Both points are proven by straightforward inspection of the rewrite rules defined in Figures 6 and 7. The idea is that none of them, read from right to left, introduces a new \boxtimes -cell, thus from $\Pi' \subseteq \mathcal{T}(R')$ it follows that $\Pi \subseteq \mathcal{T}(R)$; whereas the only rewrite rule, read from left to right, that introduces a new \boxtimes -cell is the “empty box” one (Figure 7g), so if $\Pi \xrightarrow{\text{Box}_i} \Pi'$ according to that and Π is a set of DiLL_0 proof-structures (in particular, no \boxtimes -cell occurs in any element of Π), then in R the only occurrence of a \boxtimes -cell is necessarily the whole content of a box, hence R is a MELL quasi-proof-structure. Finally, R is a MELL proof-structure (without “quasi”) because $\Pi \subseteq \mathcal{T}(R)$ and the Taylor expansion preserves conclusions (Remark 7). ◀

B The general case: non-atomic axioms (Section 7)

We present here (Figure 11) the rewrite rules for the general case of $\text{DiLL}_0^{\boxtimes}$ quasi-proof-structures with possibly *non-atomic axioms*. They replace the rewrite rules in Figure 7 (which are valid only for $\text{DiLL}_0^{\boxtimes}$ quasi-proof-structures with atomic axioms). The rewrite rules in Figure 11 are essentially the same as in Figure 7,¹⁰ except for the rewrite rule $?_c^i$ (Figure 7d), which is changed to Figure 11g.

When representing a $\text{DiLL}_0^{\boxtimes}$ quasi-proof-structure ρ , we write $\begin{array}{c} \boxtimes \\ \swarrow \quad \searrow \\ ?_{[i_1]} \quad \dots \quad ?_{[i_k]} \quad i \end{array}$ for a \boxtimes -cell whose outputs i_1, \dots, i_k are either conclusions (as i) of ρ , or inputs of $?$ -cells whose outputs are conclusions of ρ .

¹⁰Up to the fact that here an output of a \boxtimes -cell is either a conclusion of the $\text{DiLL}_0^{\boxtimes}$ quasi-proof-structure ρ or the input of a $?$ -cell whose output is a conclusion of ρ , see below.

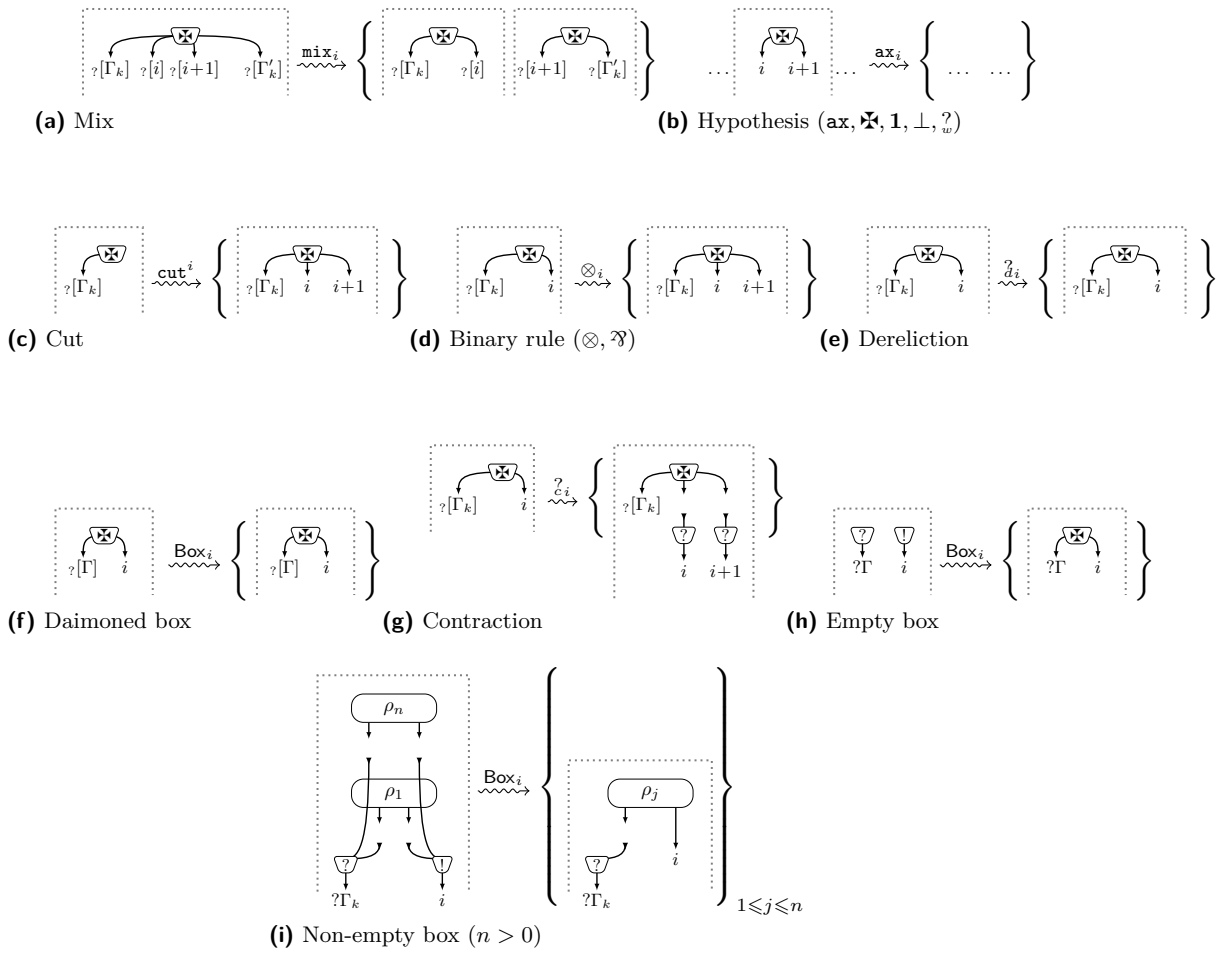

■ **Figure 11** Actions of elementary paths on \mathbf{X} -cells and on a box in $\text{qDiLL}_0^{\mathbf{X}}$.