

Travelling wave solutions for a quasilinear model of Field Dislocation Mechanics

Amit Acharya^a, Karsten Matthies^b, Johannes Zimmer^{b,*}

^a*Civil & Environmental Engineering, Carnegie Mellon University, Pittsburgh, PA 15213-3890, United States of America*

^b*Department of Mathematical Sciences, University of Bath, Bath BA2 7AY, United Kingdom*

Abstract

We consider an exact reduction of a model of Field Dislocation Mechanics to a scalar problem in one spatial dimension and investigate the existence of static and slow, rigidly moving single or collections of planar screw dislocation walls in this setting. Two classes of drag coefficient functions are considered, namely those with linear growth near the origin and those with constant or more generally sublinear growth there. A mathematical characterisation of all possible equilibria of these screw wall microstructures is given. We also prove the existence of travelling wave solutions for linear drag coefficient functions at low wave speeds and rule out the existence of nonconstant bounded travelling wave solutions for sublinear drag coefficients functions. It turns out that the appropriate concept of a solution in this scalar case is that of a viscosity solution. The governing equation in the static case is not proper and it is shown that no comparison principle holds. The findings indicate a short-range nature of the stress field of the individual dislocation walls, which indicates that the nonlinearity present in the model may have a stabilising effect. We predict idealised dislocation-free cells of almost arbitrary size interspersed with dipolar dislocation wall microstructures as admissible equilibria of our model, a feature in sharp contrast with predictions of the possible non-monotone equilibria of the corresponding Ginzburg-Landau, phase field type gradient flow model. For walls separating slip states by a full Burgers vector, while dipolar clusters of walls and walls in a dipole can be separated by arbitrarily long dislocation-free cells, we find that walls in a pile-up cannot be similarly separated.

Key words:

A. Dislocation mechanics, A. Plasticity, A. Waves, B. Field theory

PACS: 62.20.fq, 46.40.Cd, 62.30.+d

1 Introduction

The objective of this paper is to deduce some mathematically rigorous results related to solutions of the theory of Field Dislocation Mechanics (FDM), see Acharya [2004, 2010]. FDM is a nonlinear, dynamical, dissipative PDE model of dislocation mechanics that aims to treat single and collections of dislocation defects as non-singular localisations of a dislocation density field. It includes elastic non-convexity to reflect lattice periodicity and predicts dislocation internal stress and permanent deformation due to dislocation motion. Here, we prove existence of solutions to a special, but exact, class of problems within FDM and characterise the entire class of bounded equilibria and travelling wave solutions of this class for low wave speeds.

Physically, the solutions we explore represent static and rigidly moving single or collections of planar screw dislocation walls, perpendicular to the axis of an at most homogeneously sheared cylinder. Any given wall consists of screw dislocations of the same sign, but two walls may be of different sign in this sense. A particular result is the characterisation of all equilibria of such walls under no applied deformation; i.e., the class of residually stressed, static dislocation microstructure consisting of screw dislocation walls. Walls of screw dislocations are important microstructural features that have found practical application, e.g., in epitaxial growth [Matthews, 1974] and enhancement of ductility [Wunderlich et al., 1993]. Zero stress walls are discussed in Head et al. [1993], Roy and Acharya [2005], and Limkumnerd and Sethna [2007].

Mathematically, we characterise all possible bounded equilibria of these screw wall microstructures, for two classes of drag coefficient functions, namely those with linear growth near the origin and those with sublinear growth there. We also prove the existence of travelling wave solutions for linear drag coefficient function at low wave speeds and rule out the existence of nonconstant bounded travelling wave solutions for sublinear drag coefficient functions. The governing equation is quasilinear (see (1)); it becomes degenerate if the quotient F of ϕ_x^2 and the drag coefficient function vanishes. It is this degeneracy that leads to a plethora of solutions for the equilibrium equation and the dynamic (travelling wave) equation for drag coefficient functions with linear growth. In essence, it becomes possible to glue together certain solution segments, as discussed below, to obtain new solutions. This intuitive approach can be made

* Corresponding author. Tel.: ++44 (0)1225 38 60 97, Fax: ++44 (0)1225 38 64 92

Email addresses: acharyaamit@cmu.edu (Amit Acharya),
k.matthies@bath.ac.uk (Karsten Matthies), zimmer@maths.bath.ac.uk
(Johannes Zimmer).

URLs: <http://www.ce.cmu.edu/people/faculty/acharya.html/> (Amit Acharya), <http://www.maths.bath.ac.uk/~km230/> (Karsten Matthies),
<http://www.maths.bath.ac.uk/~zimmer/> (Johannes Zimmer).

rigorous with a suitable variant of the notion of viscosity solutions, defined in Appendix A. The notion is weaker than that of the more classical case of proper equations, and we show that for the equation under consideration, no comparison principle holds. (Viscosity solutions were first developed for Hamilton Jacobi equations, where an interpretation based on viscous regularisations can be made; in the context considered here, viscosity solutions are not related to physical viscosity).

The equation under consideration is related to the van der Waals energy and its gradient flow. There is an enormous body of beautiful results on this subject, which we cannot attempt to survey appropriately, so we just mention a few papers by Carr et al. [1984], Fife and McLeod [1980/81], Carr and Pego [1989] and Bronsard and Kohn [1991]. A key difference between the analysis of equations of the type $\phi_t = \epsilon^2 \phi_{xx} - f(\phi)$ and the equation considered here is the degeneracy of our equation (see (1)), which brings with it a multitude of equilibria (and travelling waves) and requires us to consider a suitable concept of viscosity solutions. This difference enables a crucial physical prediction to be made, and we discuss this feature in Section 6. For studies of attractors of scalar nondegenerate parabolic equations, we refer the reader to Fiedler and Rocha [1996] and Härterich [1998]. We also mention related work by Alber and Zhu [2005] on a model for martensitic phase transitions which involves a degenerate parabolic equation which resembles the equation studied here for the constant drag coefficient function. Alber and Zhu [2005] prove the existence to an initial value problem by introducing a regularisation of the term responsible for the degeneracy and considering the limit of vanishing regularisation.

Walls of singular screw dislocations in the linear elastic context are a somewhat frequently discussed topic; some representative samples are Li and Needham [1960], Hovakimian and Tanaka [1998], Roy et al. [2008] and of course the classic book by Hirth and Lothe [1982]. To our knowledge, there is no prior work that considers mathematically rigorous analysis of a dynamic model of dislocations with elastic nonconvexity. The analysis that comes closest to our considerations is that of Carpio et al. [2001] but they consider dislocation configurations that do not interact through their stress fields.

The paper is organised as follows. Section 2 contains a brief description of the PDE model we consider. Section 3 characterises all bounded equilibrium solutions, both for linear and superlinear F (that is, linear and sublinear drag coefficient function). Section 4 studies travelling wave solutions for the model discussed in this paper. Some of the equilibrium and the travelling wave solutions have to be interpreted in the sense of viscosity solutions. To make the article self-contained, a definition of viscosity solutions is given in Appendix A. A brief discussion is the content of Section 6.

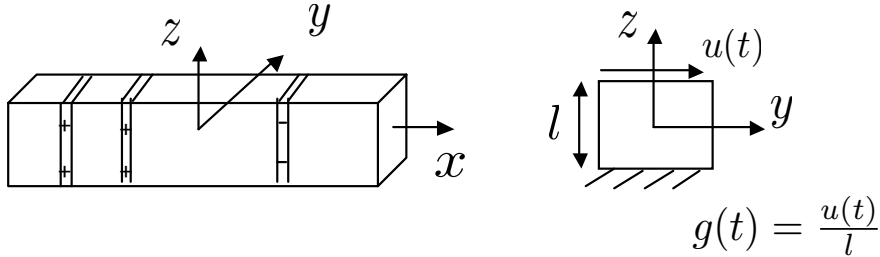

Fig. 1. Coordinates in the infinite cylinder under consideration.

2 Governing equation for the dynamics of screw dislocation walls

We consider an infinite cylinder, of rectangular cross section for definiteness, containing walls of screw dislocations. The bottom of the cylinder is held fixed and the cylinder is sheared on the top surface by an applied displacement boundary condition along the horizontal in-plane direction. The applied displacement is spatially uniform on the top surface. These facts are described schematically in Fig. 1. We describe briefly the elements of an ansatz leading to an exact problem in one spatial dimension; details of the derivation can be found in Acharya [2010].

All fields are assumed to be uniform in y and z and therefore can be thought of mathematically as being only functions of x and t , where t is time. Further, u represents the displacement on the top surface of the cylinder in the y direction, and g represents the yz component of the total shear distortion. The only non-zero plastic distortion component is ϕ , which represents plastic shearing in the y direction, on planes perpendicular to z . Then

$$\phi_x := \frac{\partial \phi}{\partial x}$$

represents the only component of the dislocation density field representing screw dislocations with line and Burgers vector along the y direction.

The only non-zero component (up to symmetry) of the stress tensor is τ representing a shear stress in the y direction on planes with normal in the z direction. Utilising a conservation law for the transport of dislocation density along with a simple kinetic assumption relating dislocation velocity to its driving force by a linear drag relationship, one obtains the following equation for the evolution of $\phi(x, t)$:

$$\phi_t := \frac{\partial \phi}{\partial t} = F(\phi_x) [\epsilon \phi_{xx} + \tau(g - \phi)] \quad \text{for } -\infty < x < \infty, \quad (1)$$

where we consider two natural choices for F , which is the quotient of ϕ_x^2 and the drag coefficient function. In both cases, $C > 0$ will be a constant material

parameter, essentially characterising the dissipation due to dislocation motion; under the operative assumptions, dislocations, and consequently the walls, have a velocity in only the x direction. The two choices of F are

$$\text{either } F(a) = C |a|^{1+\alpha} \text{ with } \alpha > 0 \quad \text{or} \quad F(a) = C |a| \quad (2)$$

The two choices of F arise from assuming a drag coefficient that is a constant ($\alpha = 1$), or, more generally, sublinear, growing like $\bar{C} |a|^{1-\alpha}$ near the origin with some $\bar{C} > 0$, which gives the first alternative in (2), or for the second alternative having linear growth of the drag coefficient function near the origin. Further, ϵ is a small constant with magnitude of the order of the elastic modulus times the square of the interatomic distance, and arises in phenomenologically accounting for the core energy of a dislocation.

Equation (1) is quasilinear and becomes degenerate for $F(\phi_x) = 0$. Constant solutions in space and time obviously are solutions to (1). We characterise non-constant solutions for suitable parameter regimes and choices of F and all viscosity solutions which are continuously differentiable. The suitable notion of viscosity solutions is defined in Appendix A. We remark that (1) is not proper (in the sense of viscosity solutions), and this enables us to show that there is no comparison principle for (1).

We assume the stress to be non-monotone with respect to the elastic strain in order to reflect lattice-periodicity; it depends on the elastic strain,

$$\gamma_e := g - \phi$$

(i.e., total strain minus the plastic strain in this small strain setting). It is a fundamental discovery of the elastic theory of continuously distributed dislocations due to Kröner [1981] that an adjustment of the total displacement gradient by incompatible (i.e., non-representable as a gradient) plastic distortion arising from the presence of dislocations in the body allows the prediction of correct dislocation stress fields of linear elastic singular Volterra dislocations and their smoothed counterparts, see, e.g., Acharya [2001], Roy and Acharya [2005]. When additionally adjusted for compatible plastic deformation due to the motion of dislocations, a prediction of smoothed permanent deformation of the body also becomes possible [Acharya, 2001, Roy and Acharya, 2005]. Of course, a linear elastic prescription for stress has its deficiencies, both physical and mathematical, in describing crystal dislocation mechanics. Physically, as is well known, crystal elasticity cannot be linear because of symmetry considerations related to periodicity of the lattice. Mathematically, it can be shown that in almost any reasonable dissipative, dynamical setting a localised but non-singular core cannot be sustained over time in a scalar problem for the plastic strain with a linear elastic stress-elastic strain assumption; on the other hand, in the problem for a system with such an assumption, singularities arise that

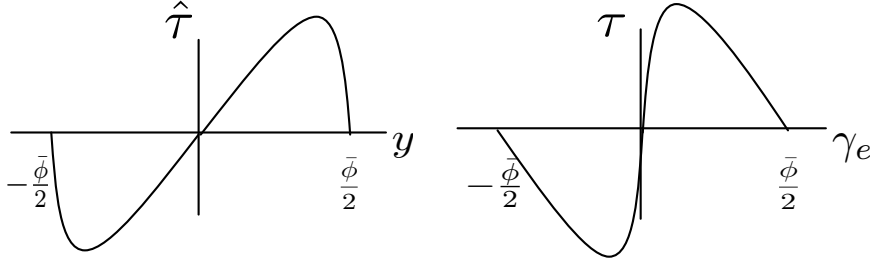

Fig. 2. Schematic plots of the functions $\hat{\tau}$ and τ . Shown is their fundamental domain.

then make the rigorous interpretation of the governing equations ambiguous due to the presence of products of singularities [Tartar, 2009]. Allowing for the core energy as above alleviates the latter problem [Tartar, 2009] while allowing for elastic nonconvexity and core energy alleviates the former problem [Acharya, 2010]. Of course, dealing with nonconvex elasticity in a small deformation setting is in itself physically defective, but given the novelty of our undertaking both in terms of modelling and analysis, it is perhaps a reasonable first step. We mention that the finite deformation theory, in the absence of core energy effects, is available in Acharya [2004].

Following Acharya [2010], we define this non-monotone stress-elastic strain relationship in terms of the function

$$\hat{\tau}(y) = -\frac{\mu}{2\left(\frac{\bar{\phi}}{2}\right)^2}y \left[y^2 - \left(\frac{\bar{\phi}}{2}\right)^2 \right]$$

periodically extended beyond $\left[-\frac{\bar{\phi}}{2}, \frac{\bar{\phi}}{2} \right]$, $\mu > 0$,

where μ is the linear elastic shear modulus. Then the shear stress, τ , is defined as

$$\tau(\gamma_e) = -\hat{\tau} \left(\gamma_e - \frac{\bar{\phi}}{2} \right). \quad (3)$$

As can be checked, the definition ensures the physical requirements that

$$\tau(0) = 0 \quad \text{and} \quad \tau'(0) = \mu.$$

Fig. 2 shows schematic plots of the functions $\hat{\tau}$ and τ over their fundamental domain.

In FDM and with reference to Fig. 1, a y - y screw dislocation field with variation in the x - z plane would in general also involve a y - x plastic distortion component yielding in addition a non-trivial y - x (and x - y) stress field as in classical elastic dislocation theory. Due to the use of a (consistent) *ansatz* here, that stress component does not arise and may be understood as due to a

smearing of the dislocation density field in the z direction. However, the stress and plastic distortion component we retain are the interesting ones in relation to screw dislocation walls, as discussed in the Section 6.

3 Equilibria of screw wall microstructures

In this section, we analyse the equilibria of (1), that is, we consider

$$0 = \frac{\partial \phi}{\partial t} = F(\phi_x) [\epsilon \phi_{xx} + \tau(g - \phi)], \quad (4)$$

which implies that $\phi(x, t) = \phi(x)$. We restrict ourselves to the case of constant g . This analysis is independent of the choice of F inasmuch as we only assume that $F(x) = 0$ only for $x = 0$, which is true for both choices of F mentioned in (2) in the Introduction.

Proposition 3.1 *We consider the set of bounded, continuously differentiable ($C^1(\mathbb{R})$) and piecewise twice continuously differentiable equilibria of (1). This set can be characterised as follows:*

- (1) *every constant ϕ is an equilibrium;*
- (2) *every bounded solution to the pendulum equation*

$$\epsilon \phi_{xx}(x) + \tau(g - \phi(x)) = 0 \quad (5)$$

is in this set;

- (3) *in addition, the set contains segments of equilibria of the types in 1 and 2 glued together such that the resulting function ϕ is $C^1(\mathbb{R})$. At every joining point ξ_0 one has $\phi'(\xi_0) = 0$.*

While the solutions of type 1 and 2 are classical solutions and in particular $C^2(\mathbb{R})$, the equilibria of type 3 are solutions in the sense of viscosity solutions (see below).

We note that the key new feature of the model (1), the prefactor involving $F(\phi_x)$, leads to a plethora of equilibria, with option 3 giving infinitely many choices of combining solution of the two other kinds, for both of which there are infinitely many solutions already.

The proof of Proposition 3.1 can be found in Subsection 5.1. Here, we give instead an intuitive motivation of the result. Fig. 4 (top panel) shows the schematic shape of the solutions we discuss first: they can have dipolar arrangements consisting of alternating walls of opposite sign (downward and upward arc on the right). Clusters of (wall) dipoles can form, which can be separated by dislocation free cells (long constant segment in Fig. 4, top panel).

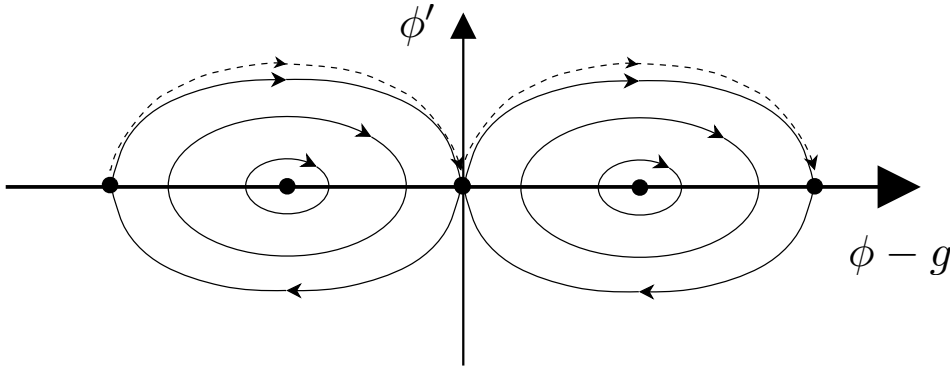

Fig. 3. Phase portrait for (5), that is, $c = 0$. The phase portrait is to be extended periodically in direction of the $\phi - g$ axis.

These dislocation-free cells can be arbitrarily long. We now show how to obtain this information from the phase portrait in Fig. 3.

Obviously, $F(\phi_x) = 0$ for every constant function ϕ , so every constant is a solution to (4). This is case 1. Next, we consider conditions under which the second term on the right of (4) vanishes. The equation

$$\epsilon\phi_{xx} + \tau(g - \phi) = 0$$

is a scaled pendulum equation, so its bounded solutions are well known and are exactly those given in case 2.

The degeneracy of the equation, however, makes it possible to join solution segments of case 1 with those of 2. This will, however only result in a continuously differentiable function if the segments originating from the pendulum equation are continued by a constant segment at points where $\phi_x = 0$.

We give in Fig. 4 (top panel) a schematic plot of one such solution. In the phase portrait in Fig. 3, it corresponds to one of the inner closed curves on the left-hand side. Namely, the first nonconstant segment is “half” a solution to the pendulum equation with $\phi_x > 0$, in the sense that only the segment $\phi_x > 0$ is captured, i.e., half a swing of a pendulum. Unlike the pendulum, the solution can rest, $\phi_x = 0$, for arbitrary long “times”, which corresponds to a constant segment in x . At any point, the solution can embark on the lower half of the pendulum arc, which gives another half swing, only now necessarily with $\phi_x < 0$. Once the line $\phi_x = 0$ is crossed, the solution can again be constant for arbitrary long or infinite times (including no time, i.e., a full swing of the pendulum). The procedure then repeats.

The arcs joining the equilibria of the pendulum equation, marked by dots in the plot of Fig. 3, are different since the “time” it takes to travel from one equilibrium to the next is infinite. The schematic plot of a corresponding solution is shown in Fig. 4 (middle panel). This situation corresponds to a

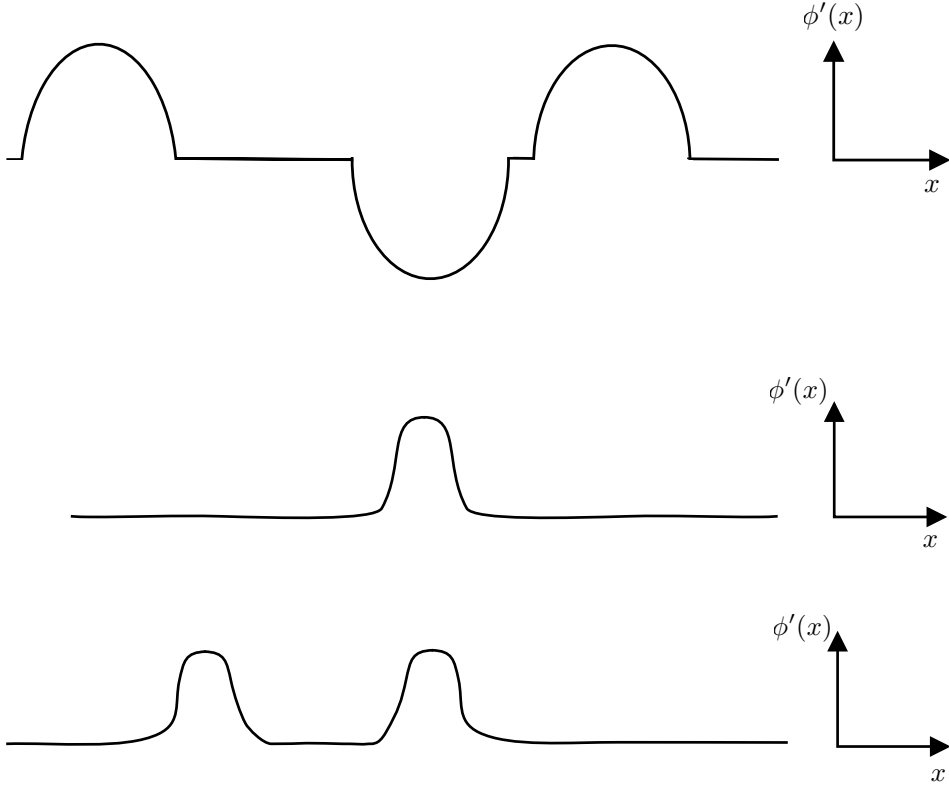

Fig. 4. Top panel: Schematic plot of a generic bounded equilibrium solution of case 3 of Proposition 3.1. Middle panel: Schematic plot of a solution connecting equilibria of the pendulum equation. Bottom panel: Schematic solution corresponding to the dashed line in the phase portrait in Fig. 3. Note that the corresponding solution ϕ corresponds to a dislocation pile-up; it becomes unbounded on unbounded domains.

single dislocation in the entire domain.

The bottom panel of Fig. 4 shows a solution corresponding to the dashed line in the phase portrait in Fig. 3. Note that this solution is not contained in the classification of Proposition 3.1; this is since ϕ becomes unbounded on the real line. Yet, it is not hard to see that all solutions with bounded ϕ' are either covered by Proposition 3.1 or correspond to a solution where the phase portrait resembles qualitatively the dashed line in Fig. 3; these solutions can be interpreted as dislocation pile-ups, i.e., dislocation configurations consisting of same sign dislocation walls.

Viscosity solutions are a concept to make the construction above, which glues together suitable solution segments, rigorous. See Appendix A for the definition; on an informal level, however, it suffices here to think of viscosity solutions as segments joined together in a continuously differentiable manner.

We close this section by demonstrating that there is no comparison principle for (4) (as well as for the travelling wave equation (6) studied in the next section), which implies that there is no comparison principle for (1). Recall

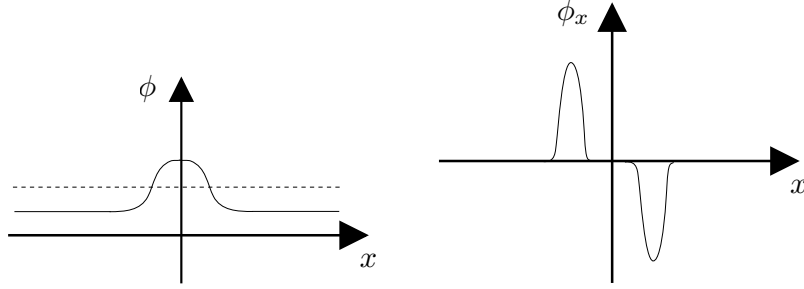

Fig. 5. Left panel: the comparison principle is violated for the equilibrium equation: shown are schematic plots of two solutions, one drawn with a solid line and one dashed. Right panel: the corresponding plot of ϕ_x , the dislocation density.

that an equation satisfies a *comparison principle* if for two solutions ϕ and ψ with $\phi \geq \psi$ on the boundary of the domain, it holds that $\phi \geq \psi$ on the entire domain. It is easy to see that this does not hold in the present situation; a sketch of two solutions violating this condition is shown in Fig. 5.

4 Travelling wave solutions

In this section we characterise solutions of the type $\phi(x, t) = \hat{\phi}(x + ct) =: \hat{\phi}(\xi)$, where c is the wave speed. Below we drop the caret $\hat{\cdot}$ for simplicity. With this *ansatz*, (1) becomes

$$c\phi'(\xi) = F(\phi'(\xi)) [\epsilon\phi''(\xi) + \tau(g - \phi(\xi))] \quad \text{for } -\infty < \xi < \infty. \quad (6)$$

As before, we assume that $F(a) = 0$ only for $a = 0$. Then, if $\phi' \neq 0$, it is convenient to solve (6) for ϕ'' ,

$$\phi''(\xi) = \frac{c\phi'(\xi)}{\epsilon F(\phi'(\xi))} - \frac{1}{\epsilon} [\tau(g - \phi(\xi))] \quad \text{for } -\infty < \xi < \infty. \quad (7)$$

4.1 Sublinear drag coefficient function

We first show that, for $c \neq 0$, if the drag coefficient function is sublinear and consequently F grows faster than linear then there are no nonconstant bounded travelling wave solutions to (6). Thus there is a stark contrast between the rich zoo of solutions for $c = 0$ and constants being the only bounded (and uninteresting) travelling wave solutions for $c \neq 0$. It should be noted that this nonexistence result is particular to travelling waves and is not a claim about general time dependent solutions to (1).

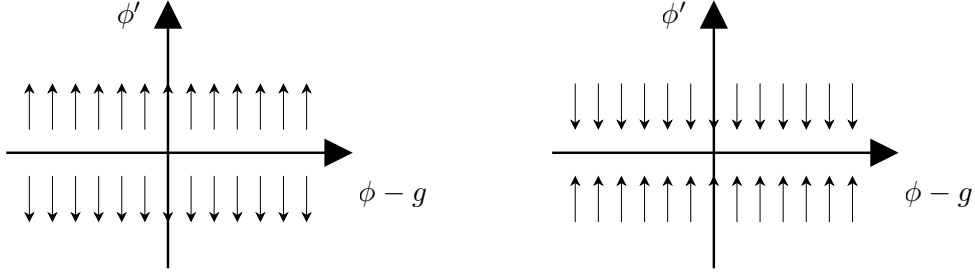

Fig. 6. Phase portrait for F superlinear, for $c > 0$ (left panel) and $c < 0$ (right panel).

Proposition 4.1 *If there is a ball $B(0, r)$ centred at 0 with radius r such that F is superlinear in $B(0, r)$ (that is, $F(a) = C|a|^{1+\alpha}$ for some $\alpha > 0$ and $C > 0$ in $B(0, r)$), then there are no nonconstant bounded solutions to (6) which are continuous and piecewise continuously differentiable for any $c \neq 0$.*

The proof is given in Subsection 5.2; the key observation is that in the relevant phase portrait (Fig. 6), ϕ' cannot approach 0 for both positive and negative times as would be required for a solution which is bounded.

4.2 Linear drag coefficient function

We now consider a drag coefficient which grows like the modulus in a neighbourhood of the origin. Unlike for the superlinear growth of F discussed in the previous subsection, there are non-constant bounded travelling wave solutions for non-zero wave speeds.

If $F(a) = C|a|$ near the origin for some $C > 0$, then (7) simplifies to

$$\phi''(\xi) = \frac{c \operatorname{sgn}(\phi'(\xi))}{C\epsilon} - \frac{1}{\epsilon} [\tau(g - \phi(\xi))] \quad \text{for } -\infty < \xi < \infty. \quad (8)$$

This equation becomes degenerate for $\phi' = 0$; it decomposes into two pendulum equations, one for $\phi' > 0$ and one for $\phi' < 0$. See Fig. 7 for a sketch of the phase portrait. The plot, as the entire analysis in this subsection, is valid only for wave speeds with $|c|$ small but nonzero.

Proposition 4.2 *The set of bounded C^1 function which are piecewise twice continuously differentiable solutions to (6) can be characterised as follows:*

- (1) every constant ϕ is a travelling wave;
- (2) nonconstant solutions consist of segments of the following types: (i) constant segments as in 1, (ii) segments of the pendulum equation for $\phi' > 0$,

$$\phi''(\xi) = \frac{c}{C\epsilon} - \frac{1}{\epsilon} [\tau(g - \phi(\xi))], \quad (9)$$

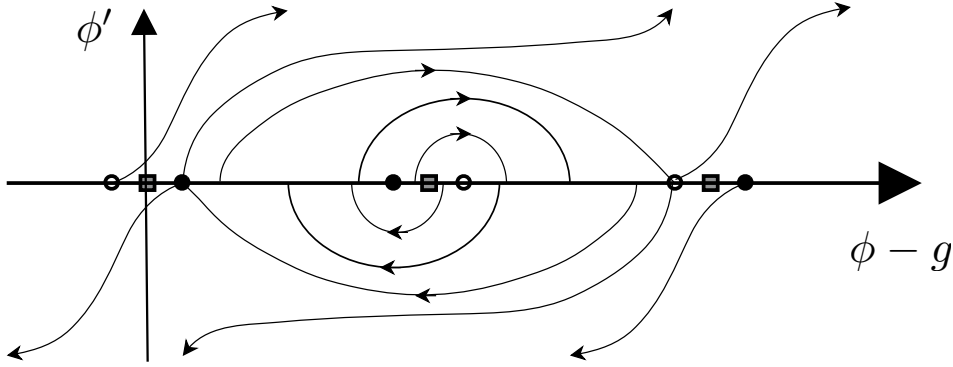

Fig. 7. Phase portrait for $F(a) = C|a|$. White circles denote steady states for $\phi' > 0$, black circles denote steady states for $\phi' < 0$. The grey squares are virtual as they represent the position of steady states for $c = 0$; they are plotted only to indicate the directions into which the steady states have moved. The plot shows the phase portrait for small and positive c . The phase portrait is to be extended periodically in direction of the $\phi - g$ axis.

(iii) segments of the pendulum equation for $\phi' < 0$,

$$\phi''(\xi) = -\frac{c}{C\epsilon} - \frac{1}{\epsilon} [\tau(g - \phi(\xi))], \quad (10)$$

glued together such that the resulting function ϕ is $C^1(\mathbb{R})$. Here any of the possibilities (i), (ii), (iii) may occur any number of times, including infinitely often or not at all. In addition, $\phi'(\xi) = 0$ holds for every joining point ξ .

While the solutions of type 1 are classical solutions and in particular $C^2(\mathbb{R})$, the travelling waves of type 2 are solutions in the sense of viscosity solutions.

The proof is again given in Subsection 5.2. The essence of the argument is simple and resembles the equilibrium case. Namely, solution segments are either constant or semi-arcs describing the solution of a pendulum equation; if these segments are glued together such that the resulting function is continuously differentiable, then one would intuitively see this function as a solution to (8); viscosity solutions make this intuition rigorous (see Appendix A). The only difference to the equilibrium case is that the phase portrait for $\phi' > 0$ cannot be obtained by reflection from that for $\phi' < 0$; the two phase portrait are also (nonlinearly) shifted, see Fig. 7.

5 Proofs of the claims

We now give the proofs to the claims made above.

5.1 Proof of Proposition 3.1

Equilibria of (4) satisfy $F(\phi_x) = 0$ or (5) pointwise. If $F(\phi_x) = 0$ holds globally, the equilibrium is of type 1 and it is of type 2 if (5) holds globally. The fact that (5) is of pendulum type allows us to study all bounded solutions rigorously by an analysis of the phase portrait, see Arnold [2006, §12] for a discussion and Fig. 3 for a plot.

If these two alternative do not hold globally but only locally then this gives rise to a solution candidate which is defined in a piecewise manner, being constant where $F(\phi_x) = 0$ and being of type 2 where (5) holds. This shows that there can be no further solution other than those which consist of segments of equilibria of the types in 1 and 2. It remains, however, to show that some of these candidates are indeed meaningful solutions. The appropriate solution concept is here that of viscosity solutions, see Appendix A. In particular, we note that the concept of viscosity solutions rules out discontinuities, and we consider solution candidates which are at least piecewise C^2 and C^0 overall, since ϕ is C^2 in each segment and it is $C^0(\mathbb{R})$ by being a viscosity solution.

We claim that the only “non-classical” piecewise C^2 solutions of (4) are viscosity solutions which connect constant segments with solutions of the pendulum equation (5) such that

$$\phi' = 0 \text{ both from the left and the right at any joining point.} \quad (11)$$

To prove the claim, we first show that solutions as described in (11) are indeed viscosity solutions. We then show that candidates with other jumps are not viscosity solutions.

To see this, we write

$$E(\phi, \phi', \phi'') := -F(\phi') [\epsilon \phi'' + \tau(g - \phi)]. \quad (12)$$

Let us consider a point ξ_0 in the interior of a segment. To see that ϕ is a viscosity subsolution, we consider $v \in C^2(\mathbb{R})$ with $v \geq \phi$ in a neighbourhood

of ξ_0 and $v(\xi_0) = \phi(\xi_0)$ ¹. Then

$$E(v, v', v'') = -F(v') [\epsilon v'' + \tau(g - v)].$$

If ξ_0 is in a piecewise constant segment, then $v'(\xi_0) = 0$ and hence

$$E(v(\xi_0), v'(\xi_0), v''(\xi_0)) = 0.$$

This shows that ϕ is a viscosity subsolution at ξ_0 and analogously it follows that ϕ is a viscosity supersolution at ξ_0 . If ξ_0 is in the interior of a segment corresponding to (5), and $v \in C^2(\mathbb{R})$ with $v \geq \phi$ in a neighbourhood of ξ_0 and $v(\xi_0) = \phi(\xi_0)$, then $\tau(g - v(\xi_0)) = \tau(g - \phi(\xi_0))$ and $v''(\xi_0) \geq \phi''(\xi_0)$. Thus

$$E(v, v', v'') = -F(v') [\epsilon v'' + \tau(g - v)] \leq 0,$$

proving that ϕ is a viscosity subsolution at ξ_0 . The proof that ϕ is a viscosity supersolution and hence a viscosity solution at ξ_0 is analogous. If ξ_0 is a joining point and $v \geq \phi$ ($v \leq \phi$) is as required for the definition of a viscosity subsolution (supersolution), then $v'(\xi_0) = 0$ and hence $E(v(\xi_0), v'(\xi_0), v''(\xi_0)) = 0$ holds once more, which proves that solutions which satisfy (11) at every joining point are indeed viscosity solutions, as claimed.

It remains to show that piecewise solutions which violate (11) are not viscosity solutions. Such solutions would combine two segments such that ϕ is continuous at the joining point ξ_0 but $\phi'(\xi) \neq 0$ from at least one side. This implies that ϕ' is discontinuous at ξ_0 since for continuous ϕ' at ξ_0 , the uniqueness theorem applied to (5) implies that the solution is classical at ξ_0 , contradicting the assumption that ξ_0 is a genuine joining point.

We consider two cases. If $\phi'(\xi_0 - 0) > \phi'(\xi_0 + 0)$, then there are no $v \in C^2(\mathbb{R})$ with $v \leq \phi$ and $v(\xi_0) = \phi(\xi_0)$ in the sense of a viscosity supersolution for ξ_0 . There are functions v in the sense of viscosity subsolutions but it is easy to see that the term $-v''(\xi_0)$ results in $E(v(\xi_0), v'(\xi_0), v''(\xi_0)) \leq 0$, contradicting the definition of a viscosity solution. One argues analogously for the case $\phi'(\xi_0 - 0) < \phi'(\xi_0 + 0)$. \square

We remark on the regularity of solutions considered here, and this paragraph can be skipped without any implication for the coming arguments. The regularity was taken to be continuous and piecewise twice continuously differentiable; we showed that such solutions are indeed continuously differentiable. If one instead considers weak solutions of (4), in the form

$$\epsilon \frac{\partial}{\partial x} G \left(\frac{\partial \phi}{\partial x} \right) = -F \left(\frac{\partial \phi}{\partial x} \right) \tau(g - \phi),$$

¹ If $v \geq \phi$ ($v \leq \phi$) in a neighbourhood of ξ_0 with $v(\xi_0) = \phi(\xi_0)$ and if $\phi \in C^1$ in this neighbourhood then $v'(\xi_0) = \phi'(\xi_0)$, which can also be seen by drawing pictures.

then an inspection of the right-hand side suggests $\phi \in H_{\text{loc}}^2(\mathbb{R})$ (locally twice weakly differentiable) as notion for a weak solution, since then ϕ_x is continuous by the Sobolev embedding, which again leads to $\phi \in C^1(\mathbb{R})$ as in our case. Standard elliptic regularity theory would yield that the solutions are also piecewise C^∞ . It is worth pointing out that weak solutions and viscosity solutions agree here: any weak solution is piecewise twice continuously differentiable and $C^0(\mathbb{R})$ as shown above, and we have proved that all such solutions are viscosity solutions. Conversely, let ϕ be a viscosity solution, then one can see that $\phi \in H_{\text{loc}}^2$ and satisfies the weak formulation, so the two concepts agree here. This consideration, together with the result we obtained that the viscosity solutions are $C^1(\mathbb{R})$, indicates that this is the regularity to be expected.

5.2 Proof of the claims in Section 4

Proof of Proposition 4.1: We first consider the case $c > 0$. Suppose there are nonconstant solutions with ϕ' being positive near $\phi' = 0$. Then (7) shows that ϕ' increases near $\phi' = 0$ since ϕ'' is positive because the dominating term $\frac{c\phi'(\xi)}{\epsilon F(\phi'(\xi))}$ is positive and diverges as $\phi' \searrow 0$. Bounded solutions would have to have $\phi' = 0$ at some points or $\phi'(\xi) \rightarrow 0$ as $\xi \rightarrow \infty$; this is impossible since the vector field points out of this region, see Fig. 6. This rules out the possibility of bounded nonconstant solutions which become eventually positive as ξ increases. Analogously, for ϕ' small and negative, ϕ'' is negative and thus ϕ' is decreasing.

The previous considerations, combined with a time reversal, show that there are no nonconstant solutions for $c < 0$ either.

The phase portrait illustrates these arguments; see Fig. 6. \square

Proof of Proposition 4.2: Obviously, constant solutions are travelling waves to (6) for any speed c . For regions where $\phi' > 0$, the phase portrait is again that of a pendulum. More specifically, the equation is the one for $c = 0$ augmented by the constant $\frac{c}{C_\epsilon}$. For small c , the phase portrait will otherwise resemble the one for $c = 0$. A key difference, however, is that for $c = 0$ there used to be a orbit living in the unstable manifold of one steady state and the stable manifold of another steady state (in Fig. 3, the arc connecting the origin and the rightmost steady state). This orbit breaks into two for $c \neq 0$, with one of them being unbounded and contained in the unstable manifold of one steady state (the arc leaving the left white circle in Fig. 7) and the other orbit being in the stable manifold of another steady state (the arc ending at the rightmost white circle in Fig. 7). To explain this, we recall that the governing equation is here of pendulum type, and thus there is an energy associated to that equation

(which is not the physical energy of the system considered here). The reason for the aforementioned split is that different steady states now have different energy levels (with respect to the energy associated to the pendulum equation) and thus there is no connection between them any longer. Again, we refer the reader to Arnold [2006, §12] for an in-depth discussion of the corresponding phase portrait.

The situation for $\phi' < 0$ is similar to the one for $\phi' > 0$ and it is an easy exercise to verify that the sketch of the phase portrait in Fig. 7 is correct.

There are no bounded solutions for which $\phi' > 0$ is globally true (that is, for every $\xi \in \mathbb{R}$), and likewise there are no bounded solutions for which $\phi'(\xi) < 0$ holds for every $\xi \in \mathbb{R}$. This can be seen from Fig. 7: every bounded orbit in the upper half plane reaches the $\phi - g$ axis after finite time (which is here the travelling wave coordinate, not the physical time) both in forward- and backward time except the arc ending at the white circle denoting a steady state; the latter takes infinitely long to reach that state but started at a point with $\phi' = 0$ at finite time.

We now consider solution candidates which consist of a number (possibly none) of constant segments, solutions to (9) and solutions to (10) (again, these segments may or may not be present). Let us consider a solution candidate which is $C^1(\mathbb{R})$ and consists of segments. The fact that this function is continuously differentiable implies that $\phi'(\xi_0) = 0$ holds for every genuine joining point ξ_0 , again by the existence and uniqueness theorem for ordinary differential equations.

To see that functions made out of segments join so that $\phi'(\xi_0) = 0$ at every joining point ξ_0 are viscosity solutions, one argues analogously to the proof of Proposition 3.1. The argument is essentially identical since the difference between the static equation (4) and the travelling wave equation (6) is the term $c\phi'(\xi)$; for viscosity test functions v , one has $v'(\xi_0) = \phi'(\xi_0)$ and hence this term results in an immaterial shift. This shift invariance also makes it possible to rule out segments joint with at least one one-sided slope being different from 0, very much in the vein of the proof of Proposition 3.1. \square

6 Discussion

As shown above, equation (1) admits many equilibria and travelling wave solutions, at least for small wave speeds, if the drag coefficient function has linear growth. While the existence of equilibria is independent of the growth of $F(\phi_x)$, the travelling waves disappear for superlinear growth of F .

The degenerate character of the equation makes the analysis of solutions more interesting, and we hope to have convinced the reader that viscosity solutions are here the appropriate concept (in the framework presented in the appendix). The governing equation (1) actually derives from a balance law for the dislocation density (which can be formally obtained by taking a spatial derivative of (1)). Quite separate from the use of any constitutive assumptions (e.g., $\epsilon = 0$ or $\epsilon \neq 0$), such a balance law implies jump conditions (Rankine-Hugoniot) at surfaces of discontinuity. In situations when solutions do not contain jumps in dislocation density, such a jump condition implies that the plastic strain rate—the right hand side of (1)—has to be continuous (in this one-dimensional setting). It is interesting to note that the viscosity solutions put forward in this paper satisfy this jump condition. A primary mathematical result of this paper is that solutions considered here cannot have jumps in the dislocation density, or kinks in the plastic distortion profile.

Our results indicate the possibility of having pile-ups of same sign walls, dipolar arrangements consisting of alternating walls of opposite sign, and clusters of (wall) dipoles separated by dislocation free cells. These dislocation-free cells can be arbitrarily long. Individual walls in the pile-ups connect slip states differing by $\bar{\phi}$ (strain corresponding to slip of one Burgers vector). The region between two such walls contain small, but non-zero, dislocation density. The spatial extent of these low dislocation density regions, however, cannot be arbitrary in the case of these pile-up configurations in contrast to the case of individual dipoles or dipolar clusters separated by dislocation free cells. The individual walls in the dipolar arrangements connect slip states necessarily separated by $\bar{\phi} - \epsilon$, $\epsilon > 0$, where ϵ can be as small as desired. Furthermore, for $0 < a < b < c < d \leq \bar{\phi}$, a wall connecting a to b cannot be in equilibrium with another wall of the same sign connecting c to d .

The equilibria representing clustered (wall) dipoles separated by dislocation free cells of almost arbitrary size are the idealised representation in this one-dimensional model of observed cell microstructures of varying size distribution in plastic deformation, and may also be interpreted in terms of persistent slip band (PSB) ladder structures in fatigue². It is important to observe that if the leading F term was absent in Section 3, i.e., $F = 1$ as in the Ginzburg-Landau based phase field model, then all non-monotone equilibria would necessarily have to be periodic. Thus cell-wall microstructures cannot be predicted by the phase field models, at least within this one-dimensional idealisation. The degeneracy available in Section 3 that arises from a conservation law for ϕ_x with implications of particle-like transport and with the energy being non-convex in the variable ϕ is what allows the existence of cell-dipolar wall equilibrium microstructure. The structure of this equation is also different from the phase-field setting of the Cahn-Hilliard equation which also deals with a non-convex

² Albeit, in the PSB case edge dislocations comprise the dipolar walls.

energy in the order parameter and a conservation law, but there the conservation law is for the order parameter field itself (and not its derivative), and there is no implication of particulate transport built into the flux field as in our case.

An interesting result of our work is that the stress field corresponding to a wall of parallel screw dislocations, corresponding to the heteroclinic equilibria, is short-ranged with variation like $\tanh x \operatorname{sech}^2 x$ (as can be deduced from the explicit result in Acharya [2010]). The solutions investigated here, both in the static and the dynamic case, decay quickly (see, for example, Fig. 4, top panel, for a schematic plot). Indeed, the non-constant parts, necessarily have the exponential decay of the oscillator equation. On the other hand, in classical dislocation theory with linear elasticity, it is shown that the y - z stress field of an (in)finite wall is long-ranged, with the infinite wall result asymptoting to a constant and the finite wall result varying like $\sim 1/x$ [Li and Needham, 1960]. This fact led Li and Needham [1960] to conclude that such walls cannot be stable. However, Hovakimian and Tanaka [1998] consider a stability calculation for a model that effectively treats the straight parallel dislocations in the walls as particles following Newtonian dynamics with an appropriate force law. They find that in the absence of nonlinearity in the force law, the wall is indeed dynamically unstable with respect to any disintegrating transverse fluctuation. However, when they add nonlinearity following from a non-convex Peierls type potential, a stability threshold is achieved, improving with increased dislocation spacing within the wall. In this connection, we mention that in the scalar problem considered in this paper, with $g = 0$, τ linear, $F(a) = a^2$ and $\epsilon = 0$ in (1), it can be shown that a piecewise constant initial condition on ϕ_x approximating a Dirac delta “spreads out” in time, i.e., the dislocation delocalises [Tartar, 2009]; with $\epsilon > 0$ under the same hypotheses, it is easy to check that there are no solutions of (4) of the type defined in this paper that can remotely resemble a dislocation profile. Thus, within our limited model it seems that there is no equilibria resembling a dislocation wall within the confines of linear elasticity, even without asking questions about stability of such equilibria.

Thus, it would be interesting to probe whether the short-range stress field of walls predicted by our model accounting for nonconvex elasticity is a signature of their stability to maintaining a wall-like compact form. Natural enhancements to the *ansatz* used here allows accounting for discreteness of the dislocation density distribution within the wall, and the precise nature of the decay of the stress field of a screw wall can hopefully be checked against atomistic calculations.

In this article, we do not discuss stability of solutions, and there is a reason for this. The main techniques for investigating stability rely on the maximum principle or linearisation techniques. For the stationary equation, we have

shown in Section 3 that a maximum (comparison) principle does not hold. We have not investigated the time-dependent equation in this regard. Linearisation techniques build on the notion of a uniquely defined differential. The non-differentiability of equation (1) at $\phi' = 0$ means that there is no such well-defined differential. This is a significant problem as all bounded solutions except for the heteroclinic connections have points where $\phi_x = 0$.

Acknowledgements

We gratefully acknowledge the financial support of the EPSRC through an Advanced Research Fellowship (GR/S99037/1) (JZ) and the EPSRC network ‘‘Mathematical Challenges of Molecular Dynamics: A Chemo-Mathematical Forum’’ (EP/F03685X/1). Support for AA from the US ONR through Grant N000140910301, and the US NSF through the CMU MRSEC, Grant DMR-0520425, is gratefully acknowledged. Discussion with Anish Roy on the linear elastic field of a screw dislocation wall is also acknowledged.

A Viscosity solutions

Viscosity solutions are a concept to deal with non-smooth solutions to partial differential equations, for example solutions to second order elliptic equations which are not twice differentiable. An already classical survey by Crandall et al. [1992] provides in-depth information in a very readable presentation.

We focus on elliptic equations as parabolic equations follow the same theory, with time t seen as an additional spatial variable.

An equation

$$E(u, Du, D^2u) = 0$$

where $u: \Omega \rightarrow \mathbb{R}$, Du is the first and D^2u is the second derivative is *degenerate elliptic* if

$$E(r, p, X) \leq E(r, p, Y) \quad \text{if } Y \leq X \quad (\text{A.1})$$

for every admissible r and p . In this article, we only need to consider the one-dimensional case where the order $Y \leq X$ is given by the order of \mathbb{R} . As an example, the elliptic equation $-u''(x) = f$ is degenerate elliptic (note the minus sign!).

An equation is called *proper* if E is degenerate elliptic and satisfies in addition

$$E(r, p, X) \leq E(s, p, X) \quad \text{if } r \leq s. \quad (\text{A.2})$$

The classic theory for viscosity solutions is developed for proper E , as described by Crandall et al. [1992]. Neither the equilibrium equation (4) nor the travelling wave equation (6) are proper, since τ is not monotone. Second order degenerate elliptic equations which are not proper and defined on a bounded domain with Dirichlet data are discussed by Kawohl and Kutev [1999]. We now sketch a framework for non-proper second order degenerate equations on the real line. Here, it makes sense to define viscosity solutions (unlike for other non-proper equations, such as first order equations).

A *viscosity subsolution* to a second order degenerate elliptic equation

$$E(u, Du, D^2u) = 0 \quad \text{on } \mathbb{R} \quad (\text{A.3})$$

is a function $u \in C^0(\mathbb{R})$ such that for every $v \in C^2(\mathbb{R})$ with $v(x_0) = u(x_0)$ and $v \geq u$ in a neighbourhood of x_0 it holds that

$$E(v(x_0), Dv(x_0), D^2v(x_0)) \leq 0. \quad (\text{A.4})$$

Analogously, a *viscosity supersolution* to a second order degenerate elliptic equation (A.3) is a function $u \in C^0(\mathbb{R})$ such that for every $v \in C^2(\mathbb{R})$ with $v(x_0) = u(x_0)$ and $v \leq u$ in a neighbourhood of x_0 it holds that

$$E(v(x_0), Dv(x_0), D^2v(x_0)) \geq 0. \quad (\text{A.5})$$

Finally, a *viscosity solution* to a second order degenerate elliptic equation is a solution which is both a sub- and a supersolution.

We remark that for proper E , with the same definition of a solution as above, various properties of solutions, such as a comparison principle, can be shown. For the equations considered here, while the concept of a viscosity solution is meaningful, several key properties do not hold. For example, there is *no* comparison principle, as shown in Section 3.

We remark that viscosity solutions to the travelling wave equation (6) are also viscosity solutions to the governing equation (1). We first write parabolic questions, such as (1), as degenerate elliptic equations in the variable $y := (x, t)$. To see that the viscosity solutions of Proposition 4.2 are viscosity solutions of the original equation, one needs to consider functions $v = v(x, t)$ with $v(x, t) \geq \phi(x - ct)$ (and $v(x, t) \leq \phi(x - ct)$) and $v(x_0, t_0) = \phi(x_0 - ct_0)$ and show that for

$$E(v, Dv, D^2v) := v_t - F(v_x) [\epsilon v_{xx} + \tau(g - v)],$$

it holds that

$$E(v(x_0, t_0), Dv(x_0, t_0), D^2v(x_0, t_0)) \leq E(\phi(x_0, t_0), D\phi(x_0, t_0), D^2\phi(x_0, t_0)),$$

respectively

$$E(v(x_0, t_0), Dv(x_0, t_0), D^2v(x_0, t_0)) \geq E(\phi(x_0, t_0), D\phi(x_0, t_0), D^2\phi(x_0, t_0)).$$

This is true since the function $v - \phi$ is locally C^1 and has a minimum (maximum) at (x_0, t_0) ; consequently, the first order derivatives of ϕ and v are equal and only the second derivative remains, for which the argument is as in the travelling wave setting.

References

- Acharya, A., 2001. A model of crystal plasticity based on the theory of continuously distributed dislocations. *J. Mech. Phys. Solids* 49 (4), 761–784.
- Acharya, A., 2004. Constitutive analysis of finite deformation field dislocation mechanics. *J. Mech. Phys. Solids* 52 (2), 301–316.
- Acharya, A., 2010. New inroads in an old subject: Plasticity, from around the atomic to the macroscopic scale. *Journal of the Mechanics and Physics of Solids* 58 (5), 766–778.
- Alber, H.-D., Zhu, P., 2005. Solutions to a model with nonuniformly parabolic terms for phase evolution driven by configurational forces. *SIAM J. Appl. Math.* 66 (2), 680–699 (electronic).
- Arnold, V. I., 2006. Ordinary differential equations. Universitext. Springer-Verlag, Berlin, translated from the Russian by Roger Cooke, Second printing of the 1992 edition.
- Bronsard, L., Kohn, R. V., 1991. Motion by mean curvature as the singular limit of Ginzburg-Landau dynamics. *J. Differential Equations* 90 (2), 211–237.
- Carpio, A., Chapman, S. J., Velázquez, J. L. L., 2001. Pile-up solutions for some systems of conservation laws modelling dislocation interaction in crystals. *SIAM J. Appl. Math.* 61 (6), 2168–2199 (electronic).
- Carr, J., Gurtin, M. E., Slemrod, M., 1984. Structured phase transitions on a finite interval. *Arch. Rational Mech. Anal.* 86 (4), 317–351.
- Carr, J., Pego, R. L., 1989. Metastable patterns in solutions of $u_t = \epsilon^2 u_{xx} - f(u)$. *Comm. Pure Appl. Math.* 42 (5), 523–576.
- Crandall, M. G., Ishii, H., Lions, P.-L., 1992. User’s guide to viscosity solutions of second order partial differential equations. *Bull. Amer. Math. Soc. (N.S.)* 27 (1), 1–67.
- Fiedler, B., Rocha, C., 1996. Heteroclinic orbits of semilinear parabolic equations. *J. Differential Equations* 125 (1), 239–281.
- Fife, P. C., McLeod, J. B., 1980/81. A phase plane discussion of convergence to travelling fronts for nonlinear diffusion. *Arch. Rational Mech. Anal.* 75 (4), 281–314.
- Härterich, J., 1998. Attractors of viscous balance laws: uniform estimates for the dimension. *J. Differential Equations* 142 (1), 188–211.

- Head, A. K., Howison, S. D., Ockendon, J. R., Tighe, S. P., 1993. An equilibrium theory of dislocation continua. *SIAM Rev.* 35 (4), 580–609.
- Hirth, J. P., Lothe, J., 1982. *Theory of Dislocations*, 2nd Edition. John Wiley & Sons Inc., New York.
- Hovakimian, L. B., Tanaka, S.-i., 1998. Role of Peierls energy in stabilization of a screw dislocation wall. *Scripta Mater.* 38 (11), 1615–1620.
- Kawohl, B., Kutev, N., 1999. Viscosity solutions for degenerate and nonmonotone elliptic equations. In: *Applied nonlinear analysis*. Kluwer/Plenum, New York, pp. 231–254.
- Kröner, E., 1981. Continuum theory of defects. In: Balian, R., Kléman, M., Poirier, J.-P. (Eds.), *Physics of Defects*. Vol. 35 of Les Houches Summer Series. North-Holland, pp. 217–315.
- Li, J. C. M., Needham, C. D., 1960. Some elastic properties of a screw dislocation wall. *Journal of Applied Physics* 31 (8), 1318–1330.
- Limkumnerd, S., Sethna, J. P., 2007. Stress-free states of continuum dislocation fields: Rotations, grain boundaries, and the Nye dislocation density tensor. *Physical Review B (Condensed Matter and Materials Physics)* 75 (22), 224121.
- Matthews, J. W., 1974. Misfit dislocations in screw orientation. *Phil. Mag.* 29 (4), 797–802.
- Roy, A., Acharya, A., 2005. Finite element approximation of field dislocation mechanics. *J. Mech. Phys. Solids* 53 (1), 143–170.
- Roy, A., Peerlings, R. H. J., Geers, M. G. D., Kasyanyuk, Y., 2008. Continuum modeling of dislocation interactions: why discreteness matters? *Mater. Sci. Eng. A* 486 (1-2), 653–661.
- Tartar, L., 2009. Personal communication.
- Wunderlich, W., Kremser, T., Frommeyer, G., 1993. Mobile dislocations at the α_2/γ phase boundaries in intermetallic TiAl/Ti₃Al-alloys. *Acta Metall. Mater.* 41 (6), 1791–1799.